

PMR-506TX

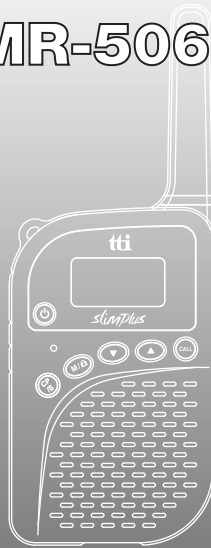

**PMR 446 TRANSCEIVER
INSTRUCTION MANUAL**



www.ttikorea.co.kr

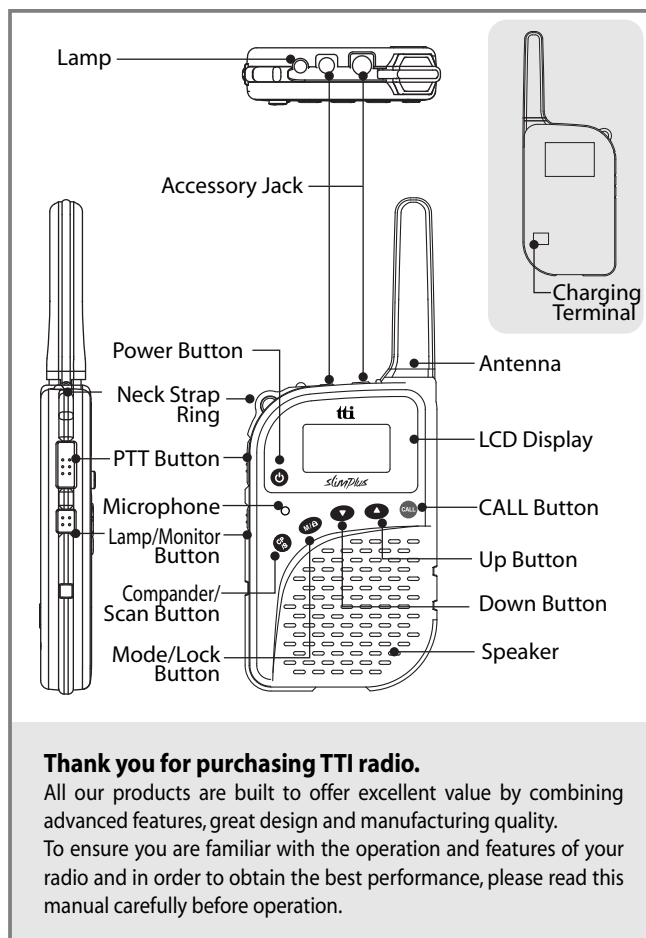

Thank you for purchasing TTI radio.

All our products are built to offer excellent value by combining advanced features, great design and manufacturing quality.

To ensure you are familiar with the operation and features of your radio and in order to obtain the best performance, please read this manual carefully before operation.

CONTENTS

1. Caution	4
2. Equipment and Accessories Supplied	5
3. Fitting the Batteries	5
4. Battery Charging	5
5. Radio Control	6
1) POWER Button	6
2) PTT Button	6
3) UP Button	6
4) DOWN Button	6
5) MODE Button	6
6) LAMP / MONITOR Button	6
7) CALL Button	6
8) SCAN / LOCK Button	7
6. LCD Display	7
7. Basic Radio Operation	7
8. Function Mode	8
9. Radio Features Explained	9
1) Volume Level	9
2) Channels	9
3) Privacy Codes (CTCSS)	9
4) Dual Watch	9
5) Hands Free (VOX) mode	10
6) Roger Beep	10
7) Key Beep	11
8) Room Monitor	11
9) Intercom	11
10) Scrambler	12
11) Call Alert	12
12) Flash Light	12
13) Monitor	12
14) Compander	13
15) Channel Scan	13
16) Privacy Code Scan/Decode	13
17) Key Lock	14
18) Display Backlight	14
19) Battery Warning	14
20) Power Save	14
10. Troubleshooting	14
11. CE Declaration	15
12. Safety Requirements	15
13. Technical Specifications	16

1. Caution

IMPORTANT - READ ALL INSTRUCTIONS carefully and completely before operating your radio and retain this manual for future reference.

NEVER connect the radio to a power source other than the supplied battery. This may damage your product.

NEVER operate your radio with the antenna less than 5cm from exposed parts of the body.

NEVER use the radio in or near a mining facility or other area which uses remotely triggered explosives or an area labelled "Blasting Area".

NEVER use or charge your radio in a potentially explosive atmosphere.

DO NOT place your radio in front of a vehicle airbag.

DO NOT operate your radio on board an aircraft.

DO NOT use your radio with a damaged antenna.

DO NOT attempt to modify your radio in any way.

ALWAYS charge your radio at normal room temperature.

ALWAYS switch off your radio where notices restrict the use of two-way radio or mobile telephones.

ALWAYS replace the accessory jack cover (if applicable) when the jack is not in use.

ONLY use TTI approved rechargeable batteries with the supplied charger.

AVOID exposing your radio to water. It is not waterproof.

AVOID storing or charging your radio in direct sunlight.

AVOID storing or using your radio where temperatures are below -20°C or above +60°C.

2. Equipment and Accessories Supplied

- 1) PMR-506TX radio (with internal battery) 1 unit
- 2) Smart Charger with Adaptor 1 unit
- 3) Instruction Manual 1 unit

3. Fitting the Batteries

The PMR-506TX uses an internal Lithium Ion or Lithium Ion Polymer battery which has been pre-installed. For removal or replacement please contact your local dealer. Unauthorised attempts to remove or replace the battery will void your warranty and may damage your product.

4. Battery Charging

To charge your radios, carefully follow these instructions.

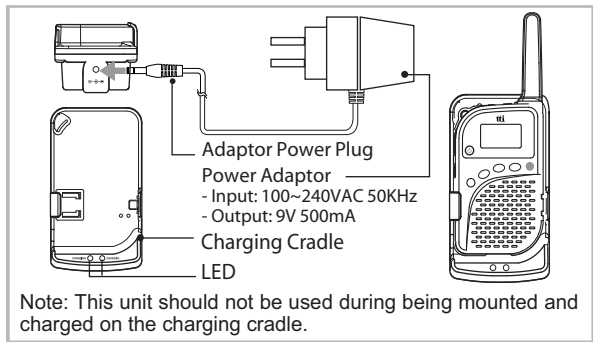

1) Charger Installation

Connect the power adaptor to the mains power supply and connect the adaptor power plug to the charger cradle. When the battery being charged the LED lights red.

2) Radio Cradling & Charging

Remove all radio accessories and insert your radios in the charging compartment until you hear locking sound. The radio will start charging and the LED will light red during charging.

3) Charging Completed

The battery charging time is typically 6~7 hours. When the battery is fully charged the LED will change to green.

5. Radio Controls

1) POWER Button

 Press and hold the POWER button for about 2 seconds. You will hear a confirmation tone to indicate the radio is on. To turn the radio off, press and hold the POWER button for about 2 seconds.

2) Push-To-Talk (PTT) Button

 Press and hold this button to speak (transmit). Release the button to listen to (receive) messages. You can only communicate with other PMR446 radios when the channel and privacy code settings are the same as yours.

3) UP Button

 Pressing this button will increase the volume. In some modes this button is used to adjust the function setting.

4) DOWN Button

 Pressing this button will decrease the volume. In some modes this button is used to adjust the function setting.

5) FUNCTION(MODE)/LOCK Button

 Press this button briefly to enter the function mode. Press again (repeatedly) to step through the function menu. Press and hold this button for 2 seconds to activate or deactivate the keypad lock.

6) LAMP / MONITOR Button

 Press this button briefly to switch the flash light lamp on or off. This flash light lamp is working only while the radio is turned on.
Press and hold this button for about 2 seconds to activate or deactivate the monitor function.

7) CALL Button

 Press this button to transmit a call melody and alert other parties to your call.

8) Compander/ SCAN Button

Press this button briefly to activate or deactivate the compander function.
 Press and hold this button for 2 seconds to activate or deactivate the scanning where appropriate.

6. LCD Display

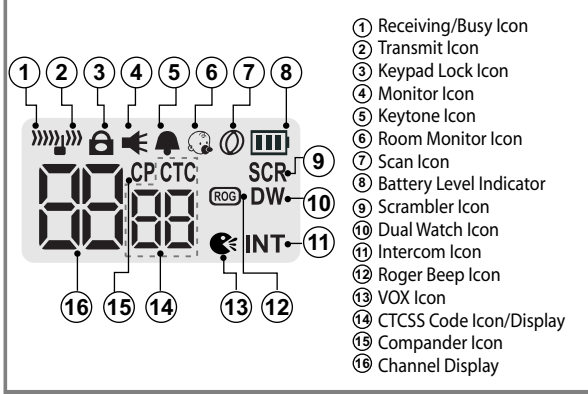

7. Basic Radio Operation

The PMR446 service which this radio uses shares channels on a 'take turns' basis. This means that other users and groups may be using any channel and privacy code combination. To communicate with other PMR446 radios, all units must be switched to the same channel (8 choices) and privacy code (38 choices).

If the combination you have selected is already in use please make an alternative selection.

- 1) Switch on your radio by pressing the Power button for 2 seconds.
- 2) Check and if necessary change the channel and privacy code settings (see Function Mode and Radio Features Explained).
- 3) To speak, hold the radio upright, about 10cm from your

mouth and press the PTT. Speak slowly and clearly towards the radio. Release the PTT when you have finished speaking. You will hear messages from other radios within range, with the same channel and privacy code setting. The appropriate icon will appear in the radio display when you receive or transmit a message.

8. Function Mode

The Function Mode allows you to program user preferences, activate features and use advanced functions (see Radio Features Explained).

To access the Function Mode press the MODE button briefly. Each press of the MODE button steps the radio sequentially through the different functions.

The radio display indicates the current function. The present setting and associated icon flash. Use the up or down button to change the setting.

Display	Functions	Settings
	change Channel	1 01 to 8 08
	change Privacy Code	1 01 to 38 38 , Off 0F
	select Dual Watch mode	1 01 to 8 08 , Off 0F
	select Hands Free (VOX) mode	Hi H1 to Low L0 , Off 0F
	activate Roger Beep	On 0n / Off 0F
	activate Key Beep	On 0n / Off 0F
	activate Room Monitor	On 0n / Off 0F
	Activate Intercom	On 0n / Off 0F
	Activate Scrambler	On 0n / Off 0F
	change Call Tone	1 01 to 3 03 , Off 0F

Press the PTT or FUNCTION button or wait for 5 seconds to store your choice.
If you do not press any key for 5 seconds your radio will return to standby automatically.

9. Radio Features Explained

1) Volume Level

There are 7 volume levels to suit your personal preference. To adjust the volume level, press the Up or Down button.  and the current volume level are shown in the radio display.

2) Channels

This radio operates on any one of the 8 PMR446 licence free channels. To communicate with other PMR446 radios, all units must be switched to the same channel and privacy code. To change the radio channel, press the FUNCTION button until the channel number flashes. Use the UP or DOWN button to select the desired channel. Press the PTT or FUNCTION button or wait for 5 seconds to store your choice.

3) Privacy Codes (CTCSS)

This radio is fitted with 38 different privacy codes (also known as CTCSS, sub-codes or sub-channels). You can select or change the current privacy code via the Function Menu. If the other units do not have privacy codes set your units privacy code to Off. Privacy codes do not prevent other radio users from hearing your conversation. They allow you to ignore messages that are using a different privacy code. There are 304 channel/privacy code combinations to help avoid interference from other users. To change the privacy code, press the FUNCTION button until the privacy code number flashes. Use the UP or DOWN button to select the desired code. Press the PTT or FUNCTION button or wait for 5 seconds to store your choice. The privacy code icon will appear when a privacy code is selected.

4) Dual Watch

Dual Watch mode allows you to monitor two channels, a primary and dual watch channel. When a signal is received on either

channel the unit will pause for 5 seconds before resuming the dual watch.

To activate the dual watch mode, first select a radio channel (see Channels) as the primary channel. To select the dual watch channel press the FUNCTION button until  appears. Use the UP or DOWN button to select the desired dual watch channel.

Press the PTT or FUNCTION button or wait for 5 seconds to store your choice and activate the dual watch.

The radio display will alternate between the primary and dual watch channels and the dual watch icon will appear.



To deactivate the dual watch press the SCAN button.

If you press the PTT button whilst receiving a signal in dual watch mode the radio will transmit on the currently displayed channel. If you press the PTT button when no signal is present the radio will transmit on the primary channel.

5) Hands Free (VOX) mode

When Hands Free (VOX) mode is selected the radio will automatically transmit when the microphone detects your voice (or other noise). It can be used with the internal microphone or an appropriate audio accessory (available separately).

To avoid accidental operation and reduce the effect of background noise there are 2 microphone sensitivity settings. (high and low)

To activate the Hands Free (VOX) mode, press the FUNCTION button until  appears. Use the UP or DOWN button to change the sensitivity level. Press the PTT or FUNCTION button or wait for 5 seconds to store your choice and activate the VOX mode. The VOX icon will appear when VOX mode is active. Repeat this process and change the sensitivity setting to  to deactivate the Hands Free (VOX) mode.

6) Roger Beep

The Roger Beep is a short tone that is automatically added to the end of your transmissions to tell other users that you have finished speaking. You can activate or deactivate the Roger Beep as required.

To change the Roger Beep setting, press the FUNCTION button until  appears. Use the UP or DOWN button to change the

setting.

Press the PTT or FUNCTION button or wait for 5 seconds to store your choice. The Roger Beep icon will appear when Roger Beep is active.

7) Key Beep

If the Key Beep is activated, your radio will emit a confirmation tone whenever you use the keypad. You can activate or deactivate the Key Beep as required.

To change the Key Beep setting, press the FUNCTION button until  appears. Use the UP or DOWN button to change the setting. Press the PTT or FUNCTION button or wait for 5 seconds to store your choice. The Key Beep icon will appear when Key Beep is active.

8) Room Monitor

The Room Monitor is similar to Hands Free (VOX) mode, but it ignores short, brief noises and uses only the highest microphone sensitivity level. When Room Monitor mode is activated, the radio will transmit for 15 seconds when it detects a continuous noise for 5 seconds or more. If the noise persists the radio will transmit for another 15 seconds.

To activate the Room Monitor mode, press the FUNCTION button until  appears. Use the UP or DOWN button to change the setting. Press the PTT or FUNCTION button or wait for 5 seconds to store your choice and activate the Room Monitor. The Room Monitor icon will appear when the Room Monitor is active.

NB The Room Monitor function is not a replacement for regularly checking the safety and security of children. If you move out of communication range you will not hear transmissions.

9) Intercom

This radio has intercom capability that allows you and your partner to communicate with each other using the intercom connector, which is optionally available.

To change the intercom setting, press the FUNCTION button until  appears. Use the UP or DOWN button to change the setting. Press the PTT or FUNCTION button or wait for 5 seconds to store your choice. The intercom icon will appear when intercom is active. Please contact your dealer to get the optional intercom accessories.

10) Scrambler

Scrambler distorts your voice upon transmit and this makes it difficult for others to listen to your communications who do not have the same scrambler decoders. To get clear voice upon receiving the scrambled voice, the receiving radio should be also in this scrambler (Descrambler) mode.

To change the scrambler setting, press the FUNCTION button until  appears. Use the UP or DOWN button to change the setting. Press the PTT or FUNCTION button or wait for 5 seconds to store your choice. The scramble icon will appear when scrambler is active.

11) Call Alert

To alert other users to your message and gain their attention you can send a Call Alert melody by pressing the CALL button.

There are three different call alert tones.

To change the Call Alert melody, press the FUNCTION button until  appears. Use the UP or DOWN button to change the setting. Press the PTT or FUNCTION button or wait for 5 seconds to store your choice.

12) Flash Light

To activate or deactivate the flash light lamp, momentarily press the Lamp/Monitor button. This flash light can be used only while the radio is turned on.

13) Monitor

The Monitor function is used to check for activity on the current channel regardless of privacy code settings. It also sets the squelch to minimum and will detect weaker signals.

To activate the Monitor press and hold the LAMP/ MONITOR button. The Monitor icon will appear when the Monitor is active.

When activated it is normal to hear background static noise.

The monitor works only while button is being pressed.

14) Compander

This compander is to minimize the background noise while receiving. To activate or deactivate the compander, momentarily press the Compander/Scan button. The compander icon will appear when the compander is active.

15) Channel Scan

The Channel Scan can be used to find or detect users on other radio channels.

To activate/deactivate the channel scan, press and hold the COMPANDER/ SCAN button. The Scan icon will appear when the channel scan is active. Scanning will only stop when you deactivate the scan function.

The radio will scan through the 8 channels. If your radio detects a valid signal the scan will pause for 5 seconds.

If you press the PTT or CALL button when your radio detects a signal, the radio will transmit on the same channel. Scanning will resume after approximately 15 seconds. Press the UP or DOWN button to resume scanning immediately.

If you press the PTT or CALL button during scanning, the radio will return to your original channel. Scanning will resume after approximately 15 seconds.

The Function Menu, Monitor and Volume Up/Down are disabled whilst scanning. To increase battery life, use the scan mode sparingly.

16) Privacy Code Scan/Decode

This radio has Privacy code scan to determine which Privacy Code (CTCSS) is in use on the current channel.

To activate the privacy code scan press the FUNCTION button until the privacy code number flashes, then press and hold the Compander/Scan button. The Scan icon will appear when the privacy code scan is active.

The radio will scan through the 38 privacy codes (CTCSS).

If your radio detects a valid signal the scan will pause for 5 seconds.

If you press the PTT or CALL button when your radio detects a signal, the radio will transmit on the same privacy code.

Scanning will resume after approximately 15 seconds. Press the UP or DOWN button to resume scanning immediately.

If you press the PTT or CALL button during scanning, the radio will return to your original privacy code. Scanning will resume after approximately 15 seconds.

The Function Menu and Volume up/down are disabled whilst scanning. To increase battery life, use the scan mode sparingly.

17) Key Lock

To avoid changing the channel or function settings accidentally this radio has a lock function.

To activate or deactivate the lock press and hold the FUNCTION/ LOCK button for about 2 seconds. The Key Lock icon will appear when the Key Lock is active. The Power, PTT, Lamp/ Monitor, Call and Volume adjustment are unaffected by the Lock.

18) Display Backlight

This display backlight will illuminate for approximately 5 seconds whenever anykey is pressed. The call key, PTT key and lamp key do not work for activating this backlight. □

19) Battery Warning

The Battery Level Indicator will blink when the battery level is low and the battery needs recharging. If necessary, refer to the instructions to recharge the battery. Operating the radio with a low battery will reduce performance.

20) Power Save

To conserve battery power the radio will automatically enter Power Save mode after a short period of inactivity. The Save icon will appear to indicate that Power Save is active. There is no user setting for Power Save.

10. Troubleshooting

If you experience problems with your PMR-506TX first check the battery power level as low batteries can cause problems such as no transmission, weak reception and poor sound quality.

Check the manual and radio display to ensure that a function (such as VOX) has not been activated by accident.

If this does not solve the problem reset your unit as follows:

- 1) Switch off the radio.
- 2) Press and hold the Up button and PTT button together.
- 3) Switch on the radio.

This will reset the radio to the factory settings and should fix most problems.

In case of further difficulty please consult your dealer or visit our website at www.ttkorea.co.kr.

11. CE Declaration

CE 2150 CE versions of the PMR-506TX which display the CE symbol on the Product label, comply with the essential requirements of the European Radio and Telecommunication Terminal Directive 1999/5/CE.

This unit can be used without license and charges in; Austria, Belgium, Bulgaria, Cyprus, Czech, Denmark, Estonia, Finland, France, Germany, Greece, Hungary, Iceland, Ireland, Italy, Latvia, Lithuania, Luxembourg, Malta, Netherlands, Norway, Poland, Portugal, Romania, Slovakia, Slovenia, Spain, Sweden, Switzerland, and U.K.

12. Safety Requirements

For charging the rechargeable batteries, only a CE approved AC adaptor complying with the following specifications must be used : * INPUT : AC 100-240V / 50Hz

* OUTPUT : DC 9V 500mA

13. Technical Specifications

1. Operating Frequencies (frequency shown in MHz) :

Ch	Frequency	Ch	Frequency	Ch	Frequency
1	446.00625	4	446.04375	7	446.08125
2	446.01875	5	446.05625	8	446.09375
3	446.03125	6	446.06875		

2. Channel Spacing: 12.5kHz

3. Power Source: 1 x Li-ion battery

4. Privacy Code/Tone Table (CTCSS frequency shown in Hz):

NO	Frequency	Ch	Frequency	Ch	Frequency
1	67.0	14	107.2	27	167.9
2	71.9	15	110.9	28	173.8
3	74.4	16	114.8	29	179.9
4	77.0	17	118.8	30	186.2
5	79.7	18	123.0	31	192.8
6	82.5	19	127.3	32	203.5
7	85.4	20	131.8	33	210.7
8	88.5	21	136.5	34	218.1
9	91.5	22	141.3	35	225.7
10	94.8	23	146.2	36	233.6
11	97.4	24	151.4	37	241.8
12	100.0	25	156.7	38	250.3
13	103.5	26	162.2	OF	0

Frequency products are Supplied by TTI Tech. Co. Ltd, Korea.
Tel: 82-2-5743055, Website: www.ttikorea.co.kr

DECLARATION OF CONFORMITY

We, TTI Tech Co., Ltd. (TTI house, 1163-4, Gaepo-dong, Gangnam-gu, Seoul, Korea), declare that the product

Kind of equipment: PRIVATE MOBILE RADIO

Type-designation: PMR-506TX

satisfies all the technical regulations applicable to the product within the scope of Council

Directives 2006/95/EC, 2004/108/EC and 99/5/EC:

Radio: EN 300 296-1 V1.2.1, EN 300 296-2 V1.2.1

EMC: EN 301 489-1 V1.8.1, EN 301 489-5 V1.3.1

Safety: EN 60950-1:2006+A11:2009, IEC 60950-1:2001 (1st Edition)

All essential radio test suites have been carried out.

Authorized representative or manufacturer :

TTI TECH CO., LTD.

TTI House, 163-4, Poi-dong, Kangnam-ku, Seoul, Korea 135-260

This declaration is issued under the sole responsibility of the manufacturer and, if applicable, his authorized Representative, and is marked in accordance with the CE marking directive 93/68/EEC.

CE 2150

Seoul, DEC . 15 , 2010

Place and date of issue

W. K. Ryu
Managing Director



Signature

TTI TECH CO., LTD.

TTI House, 163-4, Poi-dong,
Kangnam-ku, Seoul, Korea
135-260

T. +82 2 574 3055

F. +82 2 518 2419

Authorized representative

TTI TECH CO., LTD. 