



# Hello

Quick Start Guide

Smart Wi-Fi HD video intercom  
viewable from smartphone and tablet



Download the free App atHOME CONTROL





## INDEX

1. Warnings-WEEE .....	p.4
2. Network Settings .....	p.5
3. Product description .....	p.5
4. Interface and connections .....	p.6
5. Mobile Application .....	p.9
6. First Installation .....	p.9
7. Connecting Hello to other smartphones/tablets .....	p.12
8. Operation .....	p.15
9. Troubleshooting .....	p.17
10. Features .....	p.18

*TELE System Digital Srl communicates that following changes in software and/or hardware with the goal of improving the product, you could find inconsistencies between the contents of this manual and the product in your possession.*

*More information, instructions and material related to unexplained product in this guide are available on [www.telesystem-world.com/iot](http://www.telesystem-world.com/iot).*

*If you want to receive premiere news from the world of TELE System, software updates and news about products, solutions, services, and special offers, register now on the site [www.telesystem-world.com](http://www.telesystem-world.com) and/or click "like" on our [facebook.com profile/telesystem.italy](https://www.facebook.com/profile/telesystem.italy)*

## 1. Warnings-WEEE

For safe use of the appliance and for your safety, please read the following advice concerning the safety measures. Do not open or disassemble the device. Inside the unit, there may be higher voltages than that of power which could endanger the safety of the user. Unauthorized opening of the device will immediately void the warranty!

### LIQUIDS

Keep the product away from any type of liquid. It must not be installed in places where it may come in contact with spray or liquid splashing or in environments with high humidity where condensation may form.

### CLEANING

To clean the exterior, use a soft dry cloth or slightly moistened with water. Avoid the use of chemicals or solvents.

### VENTILATION

Make sure that the appliance is installed in the place where there is a good air circulation to allow for sufficient heat dissipation and avoid overheating. Do not install the speaker near any heat sources

### ATTENTION



The symbol of a crossed out trash bin indicates that it is prohibited to disperse this product into the environment or throw it in the mixed municipal waste. Whoever does not respect this rule is punishable in accordance with existing legislation. A proper disposal of the appliance enables you to avoid potential damage to the environment and human health as well as to facilitate recycling of components and materials contained in it resulting in a saving of energy and resources. The manufacturer has established a system of recovery of waste from electrical and electronic equipment (RAEE or WEEE) of the product subject to separate collection and treatment systems using plants which comply with the provisions in force. Take the product that is no longer usable (and any accessories, including batteries) to an authorized collection point that can handle waste electrical and electronic equipment. Alternatively, you can return the used equipment to the retailer when purchasing a new equivalent type or free of charge in case of household appliances by external dimensions smaller than 25 cm.

## 2. Network Settings

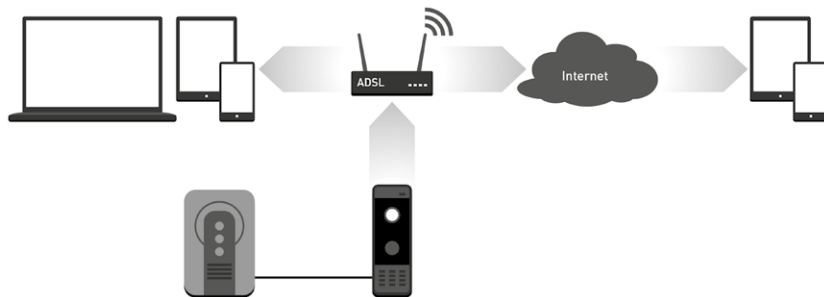

## 3. Product description

The IP video intercom system named Hello is designed as a device to establish a connection web audio/video in real time with a remote location through internet connection. The user can at any time through a mobile device receive audio/video signals in response to a visitor pressing the "call" button.

The basic function of Hello is the live transmission of audio and high-definition video thanks to H.264 compression protocol and the possibility of using it remotely thanks to the transmission protocol TCP/IP.

## 4. Interface and connections

### 4.1 External Unit

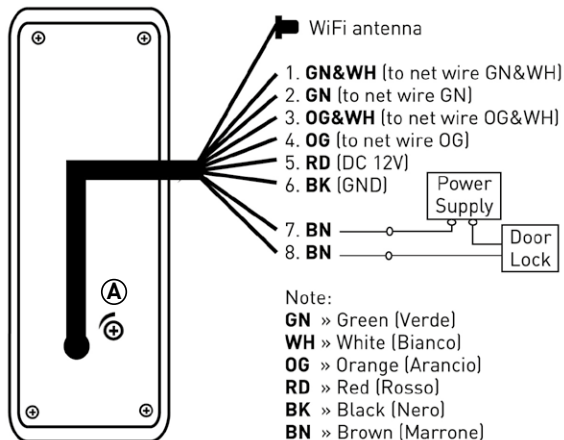

Figure 1

- |      |                              |
|------|------------------------------|
| 1.   | GN & WH: to the RJ45 adapter |
| 2.   | GN: to the RJ45 adapter      |
| 3.   | OG & WH: to the RJ45 adapter |
| 4.   | OG: to the RJ45 adapter      |
| 5.   | RD: DC 12V                   |
| 6.   | BK: (GND) Mass               |
| 7/8. | BN: unlocking the lock       |

### NOTE

To ensure a correct framing of the people who are in proximity of the videophone, Hello must be placed at a minimum height of 130 cm from the ground/floor.

**Power supply:** The videophone "Hello" power supply comes from the indoor unit which in turn must be connected to the power supply (100 ~ 240V, 50/60 Hz).

Connect the red and black cable to the indoor unit using the supplied adapter, respecting the polarity and the colors.

**By wire connection:** If the Wi-Fi signal is not available at the place of installation or you prefer a connection via cable, connect the Rj45 adapter cables as described in "Figure 2", the adapter will allow the connection of "Hello" to the Internet network via RJ45 cable.



Figure 2

#### NOTE

The adapter has two different wiring instructions ("A" and "B") to allow you to use the two standard EIA/TIA-568A and EIA/TIA-568B. While connecting the router, you must remain consistent with the standard used in the home network. The wiring scheme most widely used is the EIA/TIA-568B; you should check your system before connecting the adapter.

**Electric lock release:** The standard setting of the lock release system is "normally open" (NO). This means that the circuit (marked as XX) is open. If you press the Unlock button the circuit is closed by releasing the lock.

**Speaker volume:** From the back of the monitor, using a small screwdriver, you can adjust the volume by turning the potentiometer (marked with the letter A in "Figure 1")

## 4.2 Indoor Unit

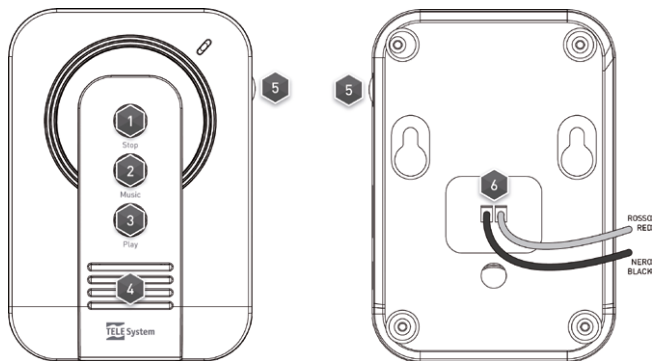

1. STOP: stops the ringtone
2. MUSIC: choice of ringtone
3. PLAY: play the ringtone
4. SPEAKERS
5. VOLUME: adjusts ringer volume
6. Power Connector: connect the two wires (red and black) to the respective inputs of the external unit respecting the color Hello (see Chapter 4, "connections outdoor unit 5 RD: DC12V" and 6 BK: Mass [GND])

### NOTE

The internal unit is designed only to issue a warning (ringtone) when a visitor presses the button on the monitor.  
 The indoor unit must be installed inside the building.  
 The duration of the ringtone is about 10s.



## 5. Mobile Application

*Hello sends a stream of data to the mobile device (smartphone and/or tablets) so that it can access the remote surveillance system (data connection). For the management and use of the camera remotely, you need to install on a specific mobile device application available on AppStore for iOS devices and GooglePlay for Android devices, the atHOME Control application.*

### NOTE

A necessary condition for this is that your mobile device be connected to a data network (e.g. 3G). For more information please contact your mobile network operator.

Through the use of the application you can see up to 4 data streams coming from different devices (Hello and/or video cameras of the same family, visit the website [www.telesystem-world.com](http://www.telesystem-world.com) to know which products can be used)

Please note that by setting the HD “high definition” video quality for watching on mobile devices you will get a data stream of greater weight and, in the case of limited available bandwidth, it will cause a greater delay of the images. It is therefore advisable to choose a video resolution in line with the situation and availability of bandwidth to the device.

## 6. First Installation

If Hello cannot be connected to the net via cable, you can use it in wireless mode (it is recommended to install the supplied antenna to increase the stability of the connection), you must have a WIFI router and a mobile device (iOS or Android) that supports this technology.

1. Install the atHOME Control application from AppStore or GooglePlay (depending on the device).
2. Turn on the WI-FI on your smartphone/tablet, launch the atHOME Control application and click + to add a new device; select “Configure and add a new wireless device”.
3. Start Hello in AP mode: Once connected to the power supply, press the “call” button for 5 seconds until you hear a beep, repeat for 3 times in a row. Hello will restart automatically in AP mode creating a WIFI network (name SSID: IP Port + UID, where UID is the label applied to the same).

4. Connect your device to the Wi-Fi network created by Hello, for iOS devices you must manually access WI-FI settings to detect available networks while Android devices can access WI-FI settings page directly from the atHOME Control application.
5. Return to atHOME Control application and login to the session "Wi-Fi device Settings"; within this session you will see the available WI-FI networks (from the router installed), select the one you want and enter the password. Be very careful to enter password and confirm. Hello will reboot automatically and will connect to the selected wireless network.
6. Connect your mobile device to the WI-FI network to which Hello has been associated.
7. The atHOME Control application will propose the Hello settings page, you can rename it; enter the default password 888888 and confirm.
8. Now, through Hello, you can communicate directly with the visitor, but also check the area covered by the camera, record images and video directly with mobile device even remotely, again thanks to the atHOME Control.

## NOTE

The following diagram illustrates the steps for a smartphone/tablet Android. The procedure with an iOS device is similar except the connection point to the network created by Hello.

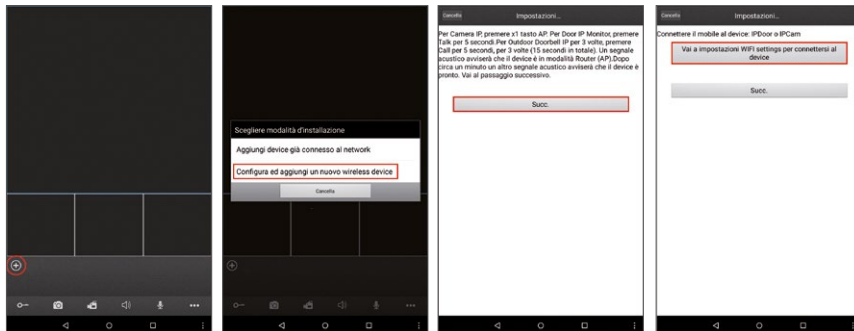



## 7. Connecting Hello to other smartphones/tablets

This procedure explains how to connect a Hello video intercom to your mobile device which has already been connected to the WI-FI network (or cable).

1. Install the atHOME Control application from AppStore or GooglePlay (depending on your device).
2. Connect your mobile device to the same network to which Hello has already been connected.
3. Start the atHOME Control application and click the + icon and choose the option "Add device already connected to the network".
4. Choose the search method/connect Hello: "Read QR code", "manual entry" or search "LAN".
5. Enter the appropriate information related to the device. The default user name is "Admin" and the password 888888. If the credentials have been changed at first or at a later time, the new username and password should be inserted.
6. Following the correct connection, Hello will appear on the main screen of the application and the user can use them at will, and activate and/or deactivate notifications.

**For example, the following is the procedure for connections through "LAN".**

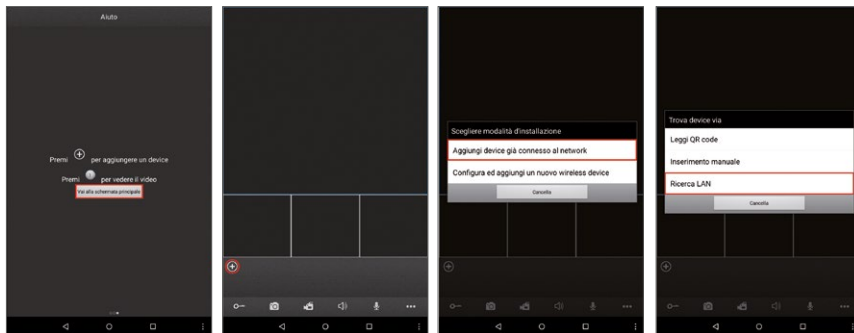

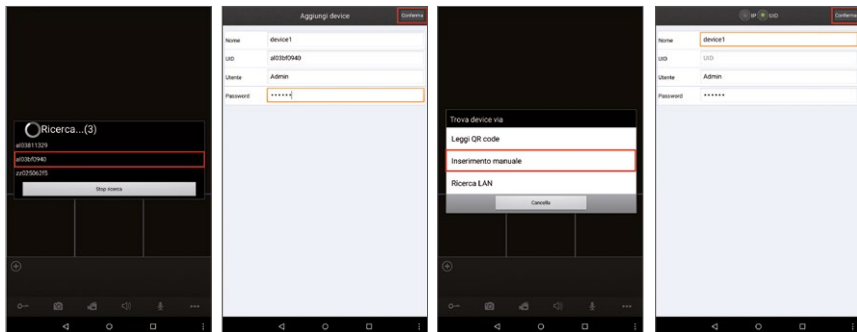

### Inclusion via QR Code (recommended)

Click "Read QR Code", scan the QR code printed on the product label or on the packaging with the camera of your mobile device, you will find the Hello identification code (UID).

### Manual entry (for experts)

Click "Manual entry" and manually enter the UID of Hello or the same IP address:

- a. **UID Mode:** After choosing "UID", complete the following fields:  
 Name: rename/sets the name.  
 UID: Hello, ID printed on the label applied to the product or its packaging.
- b. **IP Mode:** Click "IP" to access setup and complete the following fields:  
 Name: set the name.  
 Address: public IP address or DDN of Hello.  
 Port: Hello IP port that allows you to remotely access the same through smartphone/tablet; the default value is "20510".

**“LAN Search” Method**

Connect your smartphone/tablet to the WI-FI network and click “Search LAN”, the video intercom Hello connected will be visible on the list “Search ...”, click it and fill in the following fields:

User: User Name set for access. Default Admin username.

Password: password. Default password 888888

Click “Confirm” to confirm and save the settings.

**NOTE**

It is possible to set/change the following parameters for each of the 3 connection methods:

Name: set the name.

User: Set user name for access. Default Admin username.

Password: password. Default password 888888

Click “confirm” to confirm and save the settings.

**ATTENTION!**

Any changes the user name and password must be remembered, so you can make any changes to the settings at a later time.

After the correct connection of Hello, the device will be available for standard functions. Select Hello and enable the channel (circular numbered icon) to view the images on the screen.

Use the icons on the main screen for additional functionality as listed in the next chapter.

## 8. Operation

### 8.1 The Screen

While watching Live, the user can change the sort order of the page simply by dragging the video viewing area.

### 8.2 Push Notifications

On the Device list you can enable/disable the option "Push notifications". When enabled, if a visitor presses the call button, a notification will be displayed on the device (smartphone/tablet) with a warning sound. To proceed with the activation of the function make sure that your smartphone/tablet is connected to the camera.

### 8.3 Additional functions

Using the application you can check and set some functions, these are visible on the toolbar at the bottom on the main screen (left to right):





**Unlock:** allows you to open the electric lock (door/gate).

**Photo capture:** allows you to capture a frame from the selected camera video and save it as a photo.

**Record:** Click the icon to manually start a recording page. While recording the symbol "[REC]" will appear on the top right corner. Click again to stop recording.

**Audio:** allows you to activate/deactivate the microphone of Hello to hear sounds and voices near the video intercom.

The audio is active when the icon  is highlighted.

**Voice:** click the icon  the key will be highlighted, press the button  to speak into the microphone of the smartphone or click the icon  to turn off the speakerphone/page (you can talk to the visitor as if you were making a normal telephone call). Click again  to disable the function.

 Click this icon to bring up or hide additional functions.

 **Device List:** click on this to access a list of connected with the mobile device. From here you can access the edit parameters page.

 **Folder:** folder access photos and recorded videos from the application.

 Log on to the interface list to choose a device with SD card inserted from which you can reproduce a recording remotely (as shown). Click "🔍" to enter the "**Search device**", the user can choose channel, set "**registration Type** **Start**" and **end**" as search criteria, and then "**Search**" to access the list of recordings, choose one to start playback (feature available only for IP cameras)

 **Settings:** log in to the local settings: number of available videos and screen size of the screen

**[Video View]:** Select "1" (the default) and only one channel will be used for the video display on the screen. Select "4" and four channels will be available. The default choice ensures simultaneous vision of 4 pages from 4 different sources.

**[Video aspect]:** available options are "**original**" and "**full screen**".

 **Help:** access the user guide.

### **Edit parameters**

In the "**Device**", you can change some parameters of Hello. Make sure that the "Push notifications" option is turned off before proceeding, then click on the device name and then select "Edit".

To make some of these changes, the application will ask you to enter your password (default PIN: 888888)

### **The parameters that you can modify are as follows:**

**Unlock Password:** if activated, to unlock the power connected the electrical lock to Hello, you need to enter a password (for setting the password, refer to the option Change Password to unlock).

**Resolution:** the options are "**HQ**" and "**Smooth**"; "**HQ**" involves a more clear and defined image, but with a possible delay in transmission, "**Smooth**" that the video will be more fluid and faster but with less definition.

**Device Settings:** enter the menu to change some parameters related to videophone:

**Release Duration:** sets the pulse duration to the release of the electric lock.

**Notifications:** notifications from active motion sensor (only available for IP cameras).

**Motion:** activate the motion sensor (only available for IP cameras).

**Email:** enable email notifications from motion sensor (only available for IP cameras).



**Time Settings:** sync Hello with your smartphone/tablet.

**Restart device:** restarts Hello remotely.

**Change Admin password:** change the password of access to smartphone/tablet.

**User Management:** allows the administrator (Admin) to create a list of users (setting username/password credentials for access to the system), so as to limit and control the number of people who can connect to Hello.

**Unlock Password Changes:** allow you to set a password to unlock the electric lock only.

**WiFi device Settings:** allows you to connect Hello to a Wi-Fi network different from the one chosen during initial installation. If the new network is password protected, you will be asked the same. Hello will reboot and automatically connect to wireless router set.

**Delete:** removes Hello from the list.

## 9. Troubleshooting

**The mobile device does not connect to Hello:** check that the smartphone is connected to the Internet, if you connect it to the same wireless network of Hello and restart the device or reconfigure it as before (ref Chapter 6 First installation)

**Audio/video Delay:** a lag in the transmission of audio and video is normal and depends on the network speed and bandwidth availability.

**You don't get notifications on your mobile phone:** Verify that the settings for receiving notifications on your smartphone/tablet to be empowered.

**Disable notifications:** enter the list of devices connected to Hello mobile (other-> device list) and disable notifications or camera all cameras listed.

**Web Configurator (for experts only):** to access the web Configurator Hello simply insert both IP address in the address field of the web browser (Internet Explorer recommended), and then the username and password chosen during initial installation.

**NOTA:** Some functions within the Web Configurator may not be active or not available for the connected device.

The Configurator is designed to interoperate with different devices, with technical characteristics that may vary from model to model. The Web Configurator can only access the Admin user (Administrator).

## 9. Features

IMAGE SENSOR	CMOS 1,4" – 1280 x 720 pxl
MINIMUM ILLUMINATION	0.01Lux@ (F1.2, AGC ON), 0Lux with IR; 0.017Lux@ (1.6, AGC ON), 0Lux with IR
LENS	M12, F 3,6 mm
VIDEO RESOLUTION	Main stream: 720p (HD 128x720), Sub stream: QVGA
COMPRESSION	H.264
VISION MODE	Daylight color- Night b/w with IR LED lighting
AUDIO	Microphone/Speaker
ETHERNET INTERFACE	RJ45 LAN socket 10/100M
WIFI INTERFACE	802.11 b/g/n 2,4 GHz - WPS, WEP, WPA, WPA2
NIGHT VISION	IR led CUT
VIEWING ANGLE	115°
RECORDINGS	On your mobile device
S.O. COMPATIBLE	iOS and Android
WATERPROOF	SI - IP66
POWER SUPPLY (outdoor unit)	12V DC (provided by indoor unit)
POWER SUPPLY (internal unit)	100~240VAC 50/60Hz
POWER CONSUMPTION (Outdoor Unit)	12W Max.
OPERATIONS TEMPT.	-40°C ~ 60°C
DIMENSIONS (mm)	48 x 128 x 40 (outdoor unit) - 110 x 75 x 25 (internal unit)
WEIGHT (gr.)	460
ACCESSORIES	Antenna 3dB + RJ45 adapter

# SMART WiFi HD VIDEO INTERCOM *HELLO* - QUICK START GUIDE

Product Code: 26010000 - HELLO

TELE System Digital Srl declares under its own responsibility that all the products described in this user manual are satisfying the european regulations 2014/30/EU (EMC - Electromagnetic Compatibility) , 2014/35/EU (LVD - Low Voltage Directive), 2011/65/UE (RoHS - Restriction of Hazardous Substances Directive). All related documentations concerning the conformity to the regulations are available by TELE System Digital Srl and on the homepage [www.telesystem-world.com/CE/HELLO.pdf](http://www.telesystem-world.com/CE/HELLO.pdf)



TELE System Digital Srl  
Via dell'Artigianato, 35  
36050 Bressanvido (VI) - Italy  
[www.telesystem-world.com](http://www.telesystem-world.com)  
Customer Service: 199 214 455

QSG IP Doorbell HELLO Cod.95095109 Rev.01 del 10/07/15

The logo for TELE System, featuring the word "TELE" in a bold, black, sans-serif font with a red horizontal bar above it, and the word "System" in a smaller, black, sans-serif font to its right.

**TELE** System