

# PATROL® - 803PET

COMBINED  
PIR & GLASS  
BREAK DETECTOR  
WITH PET IMMUNITY  
UP TO 30KG  
INSTALLATION  
INSTRUCTIONS

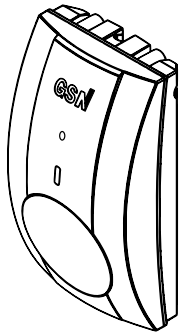

**GSN** Electronic Company Ltd.

1

## PATROL-803PET

The PATROL-803PET is a combination of PIR and acoustic glass break detector. The PATROL-803PET is a digital passive infrared detector with dual element pyrosensor, which provides the most efficient security of residential and industrial premises.

The PIR detector analyzes the environment and detects the person's motion crossing the infrared beam.

The acoustic glass break detector identifies the sounds of glass impact and breakage. Two independent optoelectronic relays of the PIR and glass break detectors, allow connecting the detectors to two independent zones in the control panel.

The detector ignores pets of up to 30kg and 1m height.

2

## FEATURES

- HI-TECH DESIGN
- DUAL TECHNOLOGY PIR & MICROPHONE
- HIGH RFI & EMI IMMUNITY
- DIGITAL PROGRAM ALGORITHM OF SIGNAL PROCESSING
- IMMUNE TO PETS UP TO 30KG
- TEST MODE FOR TWO ACOUSTIC CHANNELS
- INDIVIDUAL PIR SENSITIVITY ADJUSTMENT
- HIGH LIGHT IMMUNITY
- HERMETICALLY SEALED PYROELECTRIC SENSOR
- LOW OPERATING TEMPERATURE
- AUTOMATIC TEMPERATURE COMPENSATION

3

## DETECTOR INSTALLATION

Fix the detector vertically on solid, flat wall surface. The installation height is 2 – 2.5 meters.

For corner or ceiling installations, you can use universal brackets – models: "UBL-1112" or "UBL-1115." (Additional purchase!)

For corner installation, use knockouts located on the sloping part of the detector base.

For protecting several windows, mount the detector at optimal distance from them. If heavy blinds of curtains cover the glass, locate the detector so the blinds will not block the sound.

4

## INSTALLATION LIMITATIONS

- Do not install the detector on unstable or vibrating surfaces.
- Do not install the detector close to curtains, blinds or other items that vibrate with air movement.
- Do not install the detector close to air conditioners, air blast sources or above heat sources.
- Do not install the detector or route power wires and alarm loops next to high voltage cables.

5

## TERMINAL BLOCK CONNECTION

Connect the wires according to the scheme.

+ 12V - TAMPER RELAY 1 RELAY 2

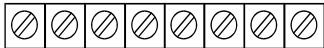

Terminals "+12V-" - for connection to the power supply of the control unit.

Terminals "Tamper" - for connection to a 24-hour normally closed protective zone in the control unit.

Terminals "Relay 1"- relay output of the PIR detector.

Terminals "Relay 2"- relay output of the glass break detector.

6

## DETECTOR ADJUSTMENT

1. Remove the front cover.
2. Set regulator S2 (PET IMMUNITY) according to animal weight.



3. Connect the power and wait for LED to stop flashing (warm-up time 60 sec).
4. Replace the cover.

5. Pass in the field of view detector. The RED LED should actively respond to your movement.

6. If necessary, increase the detector PIR sensitivity, using R18 potentiometer "PIR Sensitivity".

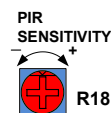

7

## LED INDICATION ON ALARM.

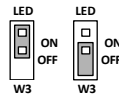

Jumper W3 will enable/disable the alarm LED.

If W3 is ON – LED will operate on alarm.

If W3 OFF – LED will not operate on alarm.

8

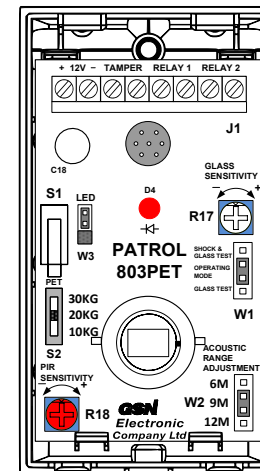

**W1** – Jumper to select operating and test modes

**W2** – Acoustic range adjustment

**S2** – Animal weight regulator

**R17** – Glass sensitivity regulator

**R18** – PIR sensitivity regulator

**S1** – Tamper button

9

## SELECTING COVERAGE RANGE

Set the jumper W2 according to the distance to the protected glass.

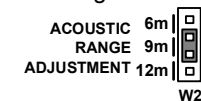

## PROTECTED GLASS TYPES

Glass Type	Min. Thickness	Max. Thickness
Plate	2 mm	14 mm
Tempered	3 mm	10 mm
Patterned	3 mm	12 mm
Laminated <sup>1</sup>	3.2 mm	14.3mm
Wired <sup>1</sup>	5 mm	6.4 mm
Coated (Triplex) <sup>1</sup>	2.5 mm	8.4 mm
Sealed insulating <sup>1</sup>	3.2 mm	6.4 mm

<sup>1</sup>The detection range of the acoustic glass break detector is reduced up to 10 meters for the following glass types: Laminated, Wired, Coated (Triplex), Sealed Insulating.

10

### GLASS BREAK TEST (ADJUSTMENT)

1. Set the jumper W1 to the "GLASS TEST" position.

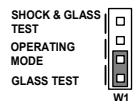

The PIR detector is off;  
The RELAY 1 and RELAY 2 are opened.

2. Replace the cover.

3. Use glass break simulator to simulate the high frequency signal of the glass breakage. The red LED will flash with each simulator activation.

4. Use the trimmer R17 marked "GLASS SENSITIVITY" to adjust in detector with more sensitivity.



11

### SHOCK & GLASS BREAK TEST

1. Set the jumper W1 to "SHOCK & GLASS TEST" position.

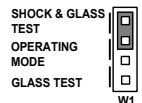

The PIR detector is off;  
The RELAY 1 is opened.  
The RELAY 2 is closed.

2. Replace the cover.

3. Tap gently the protected glass and activate the glass break simulator at the same time. The relay output of the glass break detector will open for 3 sec. The red LED will be ON.

4. After testing, set the jumper W1 to the "OPERATING MODE" position.

12

### WIDE ANGLE LENS.

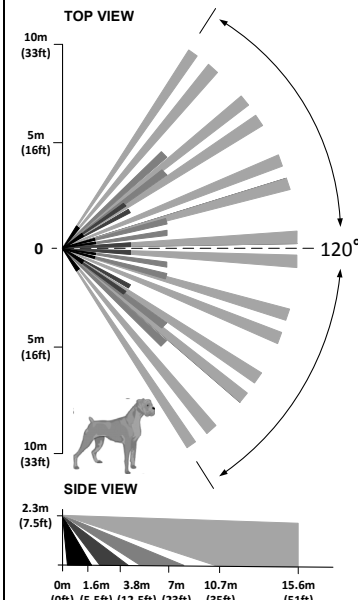

13

### VERTICAL BARRIER LENS

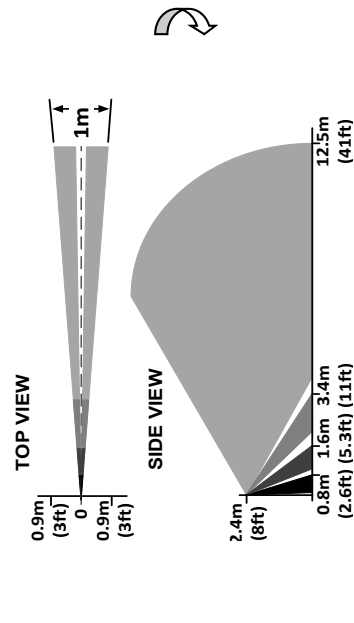

\*ADDITIONAL PURCHASE

14

### LONG RANGE LENS

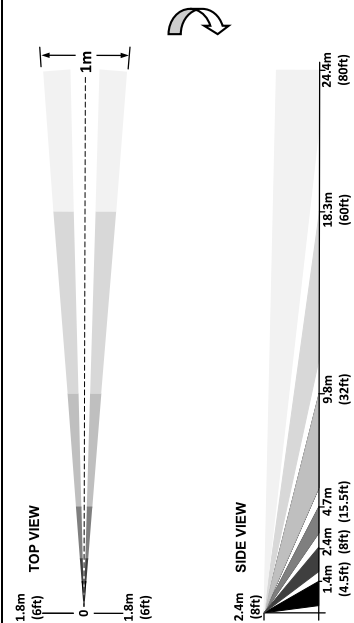

\*ADDITIONAL PURCHASE

15

### UNIVERSAL BRACKET MODELS: "UBL-1112", "UBL-1115".

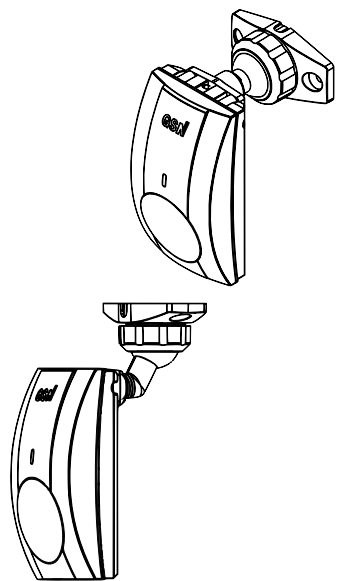

\*ADDITIONAL PURCHASE

16

### SUNSHIELD FILTER

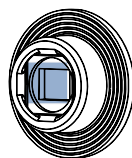

Sunshield filter for extra protection of pyroelectric sensor of detector from sunlight and car headlights.

\*ADDITIONAL PURCHASE

17

### TECHNICAL SPECIFICATIONS

Input voltage.....8.5 – 16V

Current consumption:  
In standby mode: .....17.7mA  
In alarm mode:.....19mA

Warm up period:.....60sec

PIR detection range:..15.6m x 120°

PIR detection speed range:.....0.3 – 3m/sec

Glass break detection range:.....12m x 160°

Relay output:.....  
.....NC; 60V; 100mA; 16Ω

Tamper output:.....NC; 10Ω

Alarm period:.....3sec

Reset time:.....5 ± 1sec

PET mode:.....10/20/30kg

Installation height:.....2.0 – 2.5m

18

Light immunity without sunshield filter:.....no less than 6500lux

Light immunity with sunshield filter:.....more 30000lux

Operating temperature range:.....- 30°C +60°C

Storage temperature range:.....- 50°C – +80°C

RFI immunity: 30V/m at a frequency range 30MHz-1GHz

EMI immunity.....50,000V

Dimensions:.....  
.....54mm x 33mm x 99mm

Weight:.....82gr.

19

### WARRANTY

GSN Electronic Company Ltd. warrants the product to be free from defects in materials and workmanship under condition of observance of service regulations and to be repaired or replaced under absence of mechanical damages for a limited period of five years from the date of sale.

**GSN** Electronic Company Ltd.

7 ATARA ST.  
NAZARETH ILLIT 17802  
P.O.BOX 17719  
ISRAEL

TEL: + (972) 4 6467152  
FAX: + (972) 4 6562414

WWW.GSNCOMPANY.COM

GSN@GSNCOMPANY.COM



P/N: USM0EPAT803PET\_REV.A

20