

# Mix5 • Mix8 • Mix12FX

## Compact Mixers

### OWNER'S MANUAL

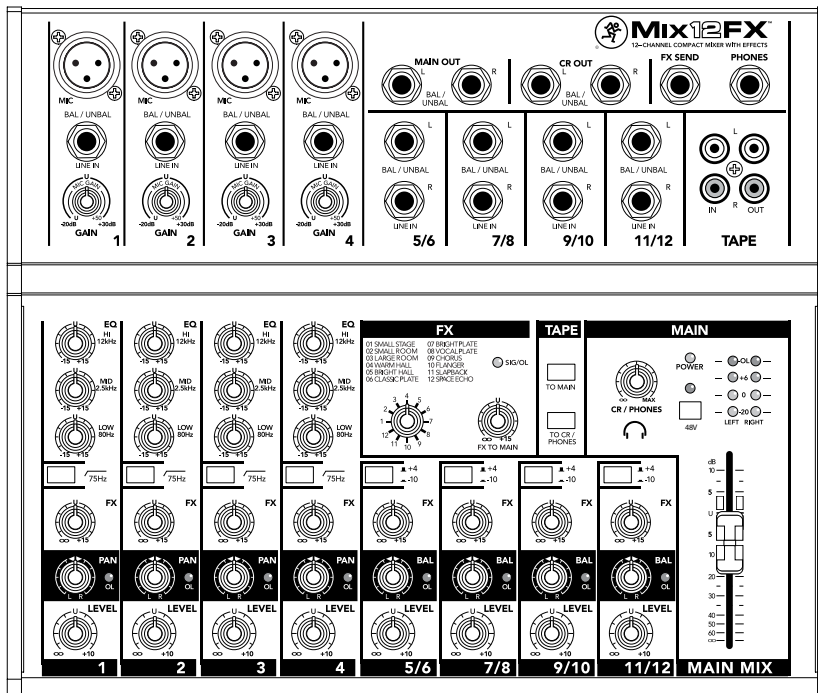
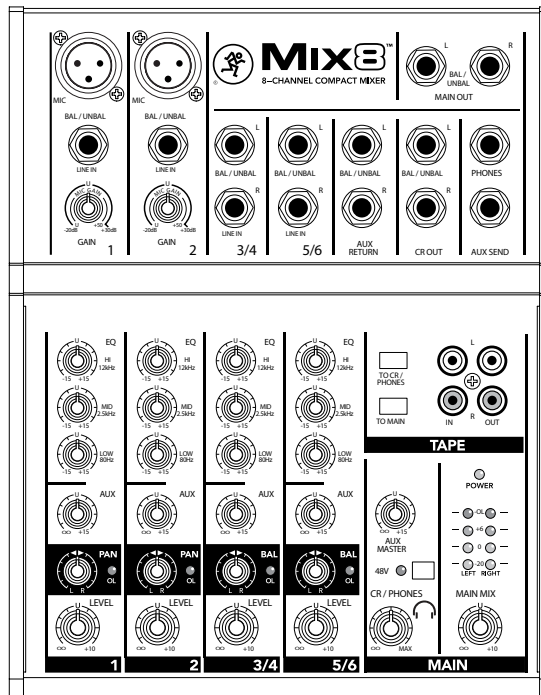
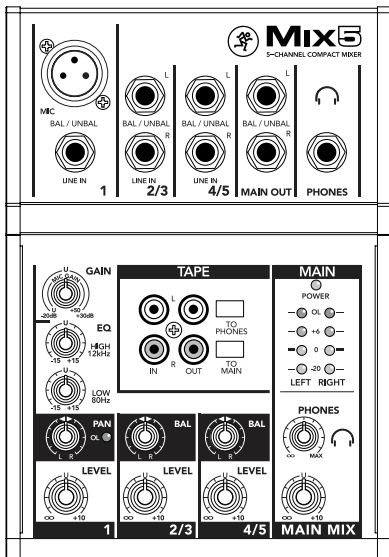

# Important Safety Instructions

1. Read these instructions.
2. Keep these instructions.
3. Heed all warnings.
4. Follow all instructions.
5. Do not use this apparatus near water.
6. Clean only with a dry cloth.
7. Do not block any ventilation openings. Install in accordance with the manufacturer's instructions.
8. Do not install near any heat sources such as radiators, heat registers, stoves, or other apparatus (including amplifiers) that produce heat.
9. Do not defeat the safety purpose of the polarized or grounding-type plug. A polarized plug has two blades with one wider than the other. A grounding-type plug has two blades and a third grounding prong. The wide blade or the third prong are provided for your safety. If the provided plug does not fit into your outlet, consult an electrician for replacement of the obsolete outlet.
10. Protect the power cord from being walked on or pinched particularly at plugs, convenience receptacles, and the point where they exit from the apparatus.
11. Only use attachments/accessories specified by the manufacturer.
12. Use only with a cart, stand, tripod, bracket, or table specified by the manufacturer, or sold with the apparatus. When a cart is used, use caution when moving the cart/apparatus combination to avoid injury from tip-over.
13. Unplug this apparatus during lightning storms or when unused for long periods of time.
14. Refer all servicing to qualified service personnel. Servicing is required when the apparatus has been damaged in any way, such as power-supply cord or plug is damaged, liquid has been spilled or objects have fallen into the apparatus, the apparatus has been exposed to rain or moisture, does not operate normally, or has been dropped.
15. This apparatus shall not be exposed to dripping or splashing, and no object filled with liquids, such as vases or beer glasses, shall be placed on the apparatus.
16. Do not overload wall outlets and extension cords as this can result in a risk of fire or electric shock.
17. The MAINS plug or an appliance coupler is used as the disconnect device, so the disconnect device shall remain readily operable.



**18. NOTE:** This equipment has been tested and found to comply with the limits for a Class B digital device, pursuant to part 15 of the FCC Rules. These limits are designed to provide reasonable protection against harmful interference in a residential installation. This equipment generates, uses, and can radiate radio frequency energy and, if not installed and used in accordance with the instructions, may cause harmful interference to radio communications. However, there is no guarantee that interference will not occur in a particular installation.

If this equipment does cause harmful interference to radio or television reception, which can be determined by turning the equipment off and on, the user is encouraged to try to correct the interference by one or more of the following measures:

- Reorient or relocate the receiving antenna.
- Increase the separation between the equipment and the receiver.
- Connect the equipment into an outlet on a circuit different from that to which the receiver is connected.
- Consult the dealer or an experienced radio/TV technician for help.

**CAUTION:** Changes or modifications to this device not expressly approved by LOUD Technologies Inc. could void the user's authority to operate the equipment under FCC rules.

**19.** This apparatus does not exceed the Class A/Class B (whichever is applicable) limits for radio noise emissions from digital apparatus as set out in the radio interference regulations of the Canadian Department of Communications.

**ATTENTION** — *Le présent appareil numérique n'émet pas de bruits radioélectriques dépassant les limites applicables aux appareils numériques de class A/de class B (selon le cas) prescrites dans le règlement sur le brouillage radioélectrique édicté par les ministere des communications du Canada.*

**20.** Exposure to extremely high noise levels may cause permanent hearing loss. Individuals vary considerably in susceptibility to noise-induced hearing loss, but nearly everyone will lose some hearing if exposed to sufficiently intense noise for a period of time. The U.S. Government's Occupational Safety and Health Administration (OSHA) has specified the permissible noise level exposures shown in the following chart.

According to OSHA, any exposure in excess of these permissible limits could result in some hearing loss. To ensure against potentially dangerous exposure to high sound pressure levels, it is recommended that all persons exposed to equipment capable of producing high sound pressure levels use hearing protectors while the equipment is in operation. Ear plugs or protectors in the ear canals or over the ears must be worn when operating the equipment in order to prevent permanent hearing loss if exposure is in excess of the limits set forth here:

Duration, per day in hours	Sound Level dBA, Slow Response	Typical Example
8	90	Duo in small club
6	92	
4	95	Subway Train
3	97	
2	100	Very loud classical music
1.5	102	
1	105	Matt screaming at Troy about deadlines
0.5	110	
0.25 or less	115	Loudest parts at a rock concert

**CAUTION**

RISK OF ELECTRIC SHOCK! DO NOT OPEN!

CAUTION: TO REDUCE THE RISK OF ELECTRIC SHOCK DO NOT REMOVE COVER (OR BACK). NO USER-SERVICEABLE PARTS INSIDE. REFER SERVICING TO QUALIFIED PERSONNEL.

The lightning flash with arrowhead symbol within an equilateral triangle is intended to alert the user to the presence of uninsulated "dangerous voltage" within the product's enclosure, that may be of significant magnitude to constitute a risk of electric shock to persons.

The exclamation point within an equilateral triangle is intended to alert the user of the presence of important operating and maintaining (servicing) instructions in the literature accompanying the appliance.

**WARNING** — To reduce the risk of fire or electric shock, do not expose this apparatus to rain or moisture.

Laita on liitettävä suojakoskettimilla varustettuun pistorasiaan.

Apparatet må tilkoples jordet stikkontakt.

Apparaten skall anslutas till jordat uttag.

**Correct disposal of this product:** This symbol indicates that this product should not be disposed of with your household waste, according to the WEEE directive (2012/19/EU) and your national law. This product should be handed over to an authorized collection site for recycling waste electrical and electronic equipment (EEE). Improper handling of this type of waste could have a possible negative impact on the environment and human health due to potentially hazardous substances that are generally associated with EEE. At the same time, your cooperation in the correct disposal of this product will contribute to the effective usage of natural resources. For more information about where you can drop off your waste equipment for recycling, please contact your local city office, waste authority, or your household waste disposal service.

# Contents

- Important Safety Instructions ..... 2
- Contents..... 3
- Features / Introduction ..... 4
- Getting Started..... 5
- Hookup Diagrams..... 6
- Mix Series Mixers..... 8
  - Front and Rear Panel Features ..... 9
    - 1. Power In and LED ..... 9
    - 2. Mic Ins ..... 9
    - 3. Phantom Power..... 9
    - 4. Line Ins..... 9
    - 5. Gain ..... 10
    - 6. Hi EQ ..... 10
    - 7. Mid EQ ..... 10
    - 8. Low EQ ..... 10
    - 9. Low Cut Switch ..... 11
    - 10. +4 / -10 Switch..... 11
    - 11. Aux..... 11
    - 12. FX..... 11
    - 13. Pan / Bal ..... 12
    - 14. OLD LEDs..... 12
    - 15. Level ..... 12
    - 16. Main Out ..... 12
    - 17. CR Out [Control Room Out]..... 12
    - 18. Phones Out ..... 13
    - 19. Aux Send..... 13
    - 20. Aux Return ..... 13
    - 21. FX Send ..... 13
    - 22. Tape In ..... 14
    - 23. Tape Out..... 14
    - 24. Tape To Main..... 14
    - 25. Tape To CR / Phones ..... 14
    - 26. CR / Phones ..... 14
    - 27. Aux Master Send..... 14
    - 28. Main Mix..... 15
    - 29. Meters ..... 15
    - 30. Preset Select..... 15
    - 31. FX to Main..... 15
    - 32. FX Sig / OL LED ..... 15
- Appendix A: Service Information ..... 16
- Appendix B: Technical Information ..... 17
  - Specifications..... 17
  - Dimensions ..... 18
  - Block Diagrams ..... 19-21
- Appendix C: Table of Effects Presets..... 22
- Limited Warranty..... 23

Please write your serial number here for future reference (i.e., insurance claims, tech support, return authorization, make dad proud, etc.)

**Purchased at:**

**Date of purchase:**



**Like us**



**Follow us**



**Watch our dang videos**

Part No. SW1073 Rev. A 09/14  
 ©2014 LOUD Technologies Inc.  
 All Rights Reserved.

# Features

- 5, 8 and 12-channel compact mixers with proven high-headroom, low-noise performance
- Mic/line inputs with studio-level audio quality
  - Multi-band EQ with clean, precise tone shaping
  - Pan, level and overload indication
  - Phantom power for studio condenser mics
  - Low cut filter (75 Hz) [Mix12FX]
- Multiple stereo 1/4" line inputs
  - +4/-10 dB and balance operation [Mix12FX]
- One aux send with stereo 1/4" returns [Mix8]
- 12 great-sounding integrated effects including reverbs, choruses and delays [Mix12FX]
- Dedicated stereo RCA inputs/outputs for playback or recording
- Main L/R outputs
- Headphone output
- Stereo control room outputs [Mix8 / Mix12FX]
- Rugged, reliable design built to last
- Extremely compact and portable

# Introduction

Mix Series Compact Mixers are reliably rugged, with the proven quality you expect from the world leader in compact mixer design.

With proven high-headroom, low-noise design preamps, Mix Series mixers sound great and maintain audio quality from any source. Plus, with their rugged metal chassis and high-quality components throughout, they are a solid investment in reliability.

An amazing value, Mix delivers a straightforward feature set that's easy to use and the sound quality you need in rugged designs built to last.

## How To Use This Manual

After this introduction, a getting started guide will help you get things set up fast. The hookup diagrams show some typical setups, while the remaining sections provide details of the Mix Series mixers.



This icon marks information that is critically important or unique to your mixer. For your own good, read and remember them.



This icon will lead you to in-depth explanations of features and some practical tips. They usually have some valuable nuggets of information.

### Need help with your mixer?

- Visit [www.720trees.com](http://www.720trees.com) and click Support to find: FAQs, manuals and other useful information.
- Email us at: [techmail@loudtechinc.com](mailto:techmail@loudtechinc.com).
- Telephone 1-800-898-3211 to speak with one of our splendid technical support chaps (Monday through Friday, normal business hours, Pacific Time).

## Getting Started

We realize that you must be really keen to try out the mixer. Please read the safety instructions on page 2, then have a look through some of the features and details in this manual.

1. Place the mixer in a nice clean and dry environment, free from dryer lint and dust bunnies.
2. Fully turn down all the knobs and faders to minimum, except for the channel EQ and pan controls, which should be centered.
3. Make sure all buttons are in the out position.
4. With the mixer unplugged, connect cords from the main outs to powered speakers (or to an amplifier connected to passive speakers).
5. Push the power supply connector securely into the mixer's connector and plug the other end into an AC outlet. The mixer may accept the appropriate voltage as indicated near the connector. The mixer will turn on automatically when connected.
6. Turn the powered speakers (or amplifiers) on.
7. Plug signal sources into the mixer, such as:
  - Microphones plugged into the mic inputs. (Engage phantom power if needed.)
  - Line-level sources such as keyboards, drum machines, or CD players plugged into the line-level inputs.
8. Be sure that the volume of the input is the same as it would be during normal use.
9. Turn up that channel's level knob to the "U" (unity gain) position.
10. Slowly bring up the main mix to a comfortable listening level.
11. Repeat steps 7 to 9 for the other channels.
12. If needed, apply some channel EQ wisely.
13. Adjust the channel level knobs to get the best mix. Keep the gain controls and levels fully down on unused channels.
14. During the performance, if you notice a channel OL LED turning on during peaks, carefully turn down that channel's gain/level control until OL does not turn on.

## Things to Remember

- Never listen to loud music for prolonged periods. Please see the Safety Instructions on page 2 for information on hearing protection.
- Always turn down the main mix and control room/phones knob down when making connections to the mixer.
- As a general guide, the Mix should be turned on first, then the speakers. As such, the mixer should also be turned off last. This will reduce the possibility of any turn-on or turn-off thumps and other noises generated by any upstream equipment from coming out of the speakers.
- Save the shipping boxes and packing materials! You may need them someday. Besides, the cats will love playing in them and jumping out at you unexpectedly. Remember to pretend that you are surprised!
- Save your sales receipt in a safe place.

# Hookup Diagrams

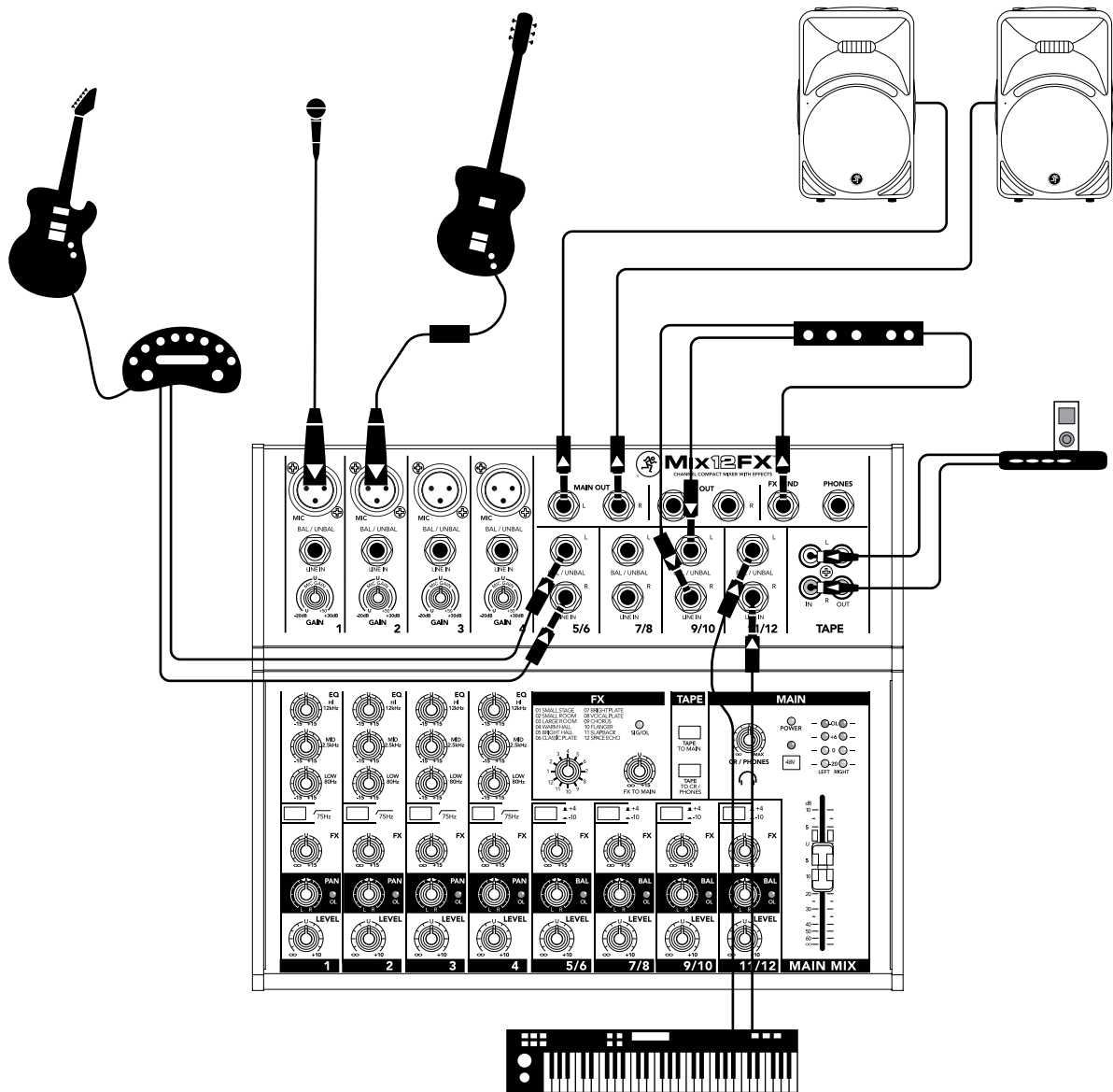

Mix Series mixers are powerful tools that offer a lot of features, but are still easy to set up and use. Let's take a look at an example of using a Mix12FX in a live PA environment.

In this example, a microphone is connected to the channel 1 mic input, the rhythm guitar to the channel 2 mic input via Direct Injection (DI), the lead guitar plays through a stereo effects processor plugged into the channel 5/6 line inputs and a synth is connected to the channel 11/12 line inputs.

The FX send jack connects to an external effects processor which is routed back into the channel 9/10 line inputs, while an MP3 player is connected to the RCA tape inputs to provide entertainment between sets. The 1/4" L/R main outs connect to a pair of SRM450v3 powered loudspeakers to please your audience.

## Live Stereo PA System

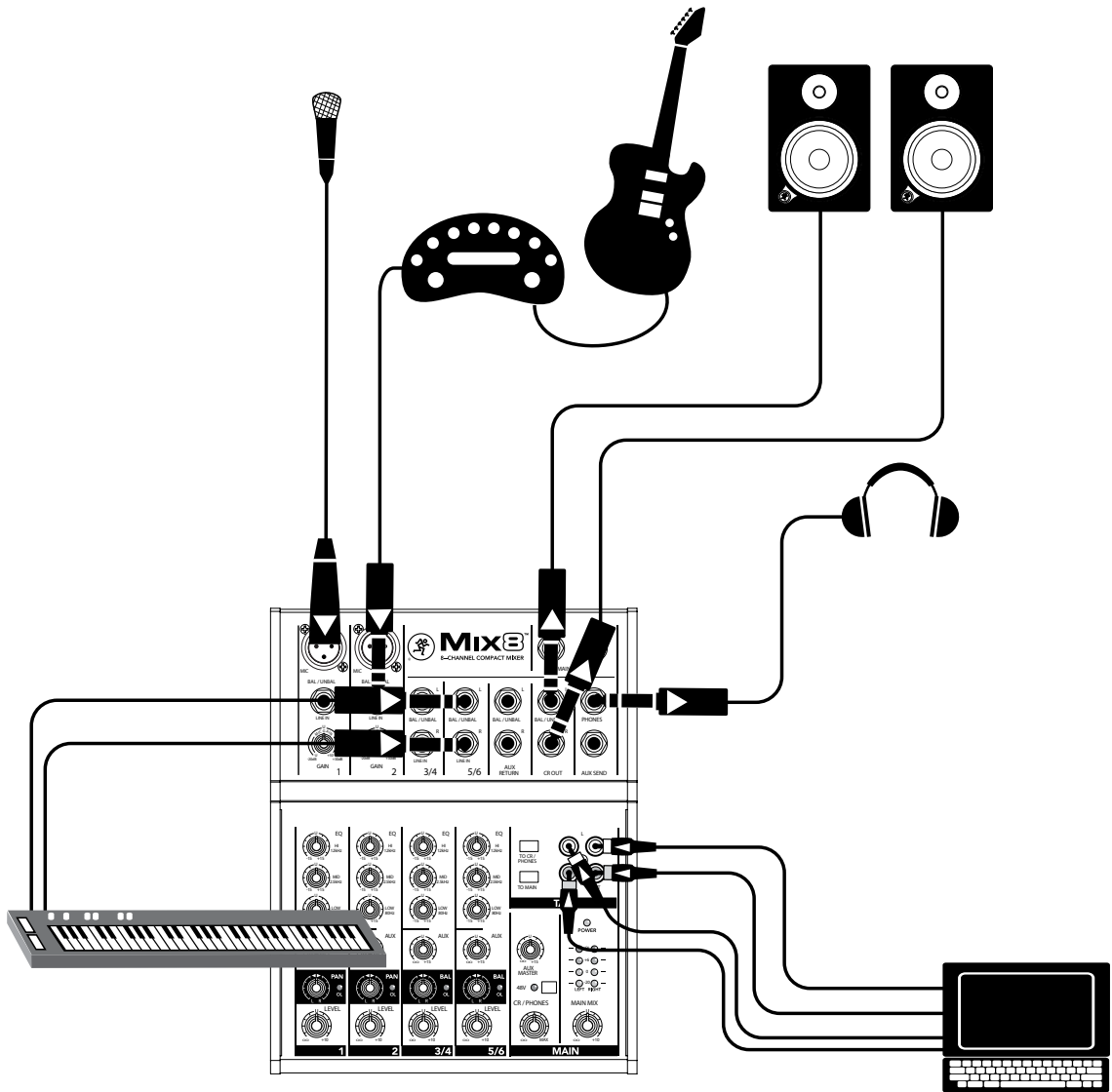

As mentioned in the previous hookup diagram, Mix Series mixers are powerful tools that offer a lot of features, but are still easy to set up and use. Now let's take a look at an example of using a Mix8 as a recording mixer.

In this example, a microphone is connected to the channel 1 mic input, the lead guitar plays through an effects processor plugged into the channel 2 line input and a synth is connected to the channel 5/6 line inputs.

A pair of MR8mk3 studio monitors are connected to the control room outputs to listen to playback of your latest masterpiece.

The RCA tape inputs and outputs are connected to a laptop. It's an easy way to get a stereo recording for posterity and use the same setup as playback of that very recording.

## Recording System

# Mix5 • Mix8

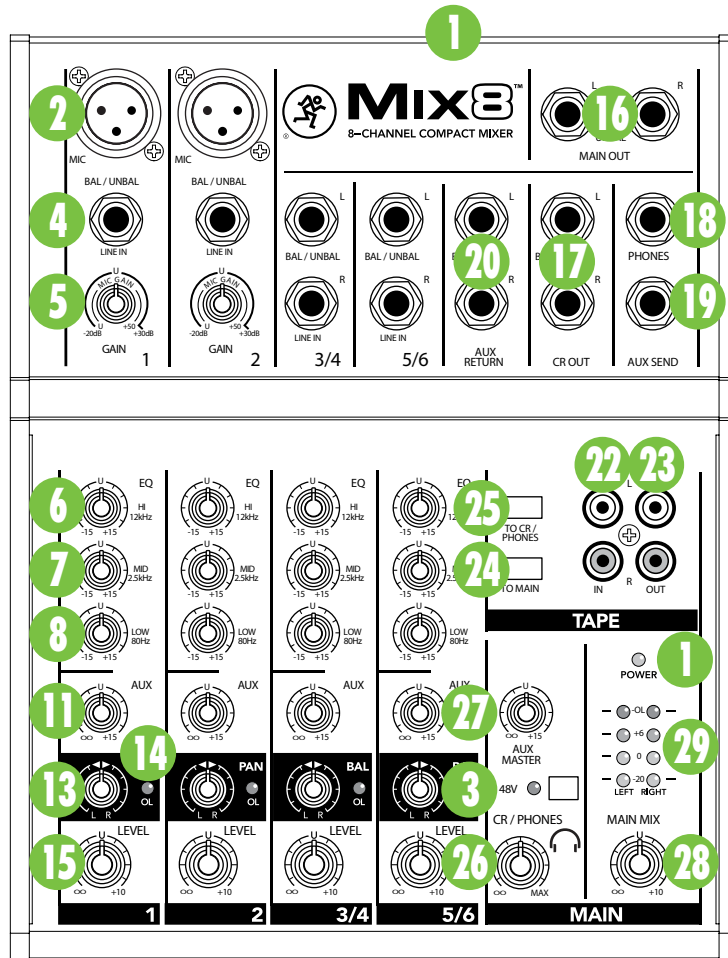

# Mix12FX

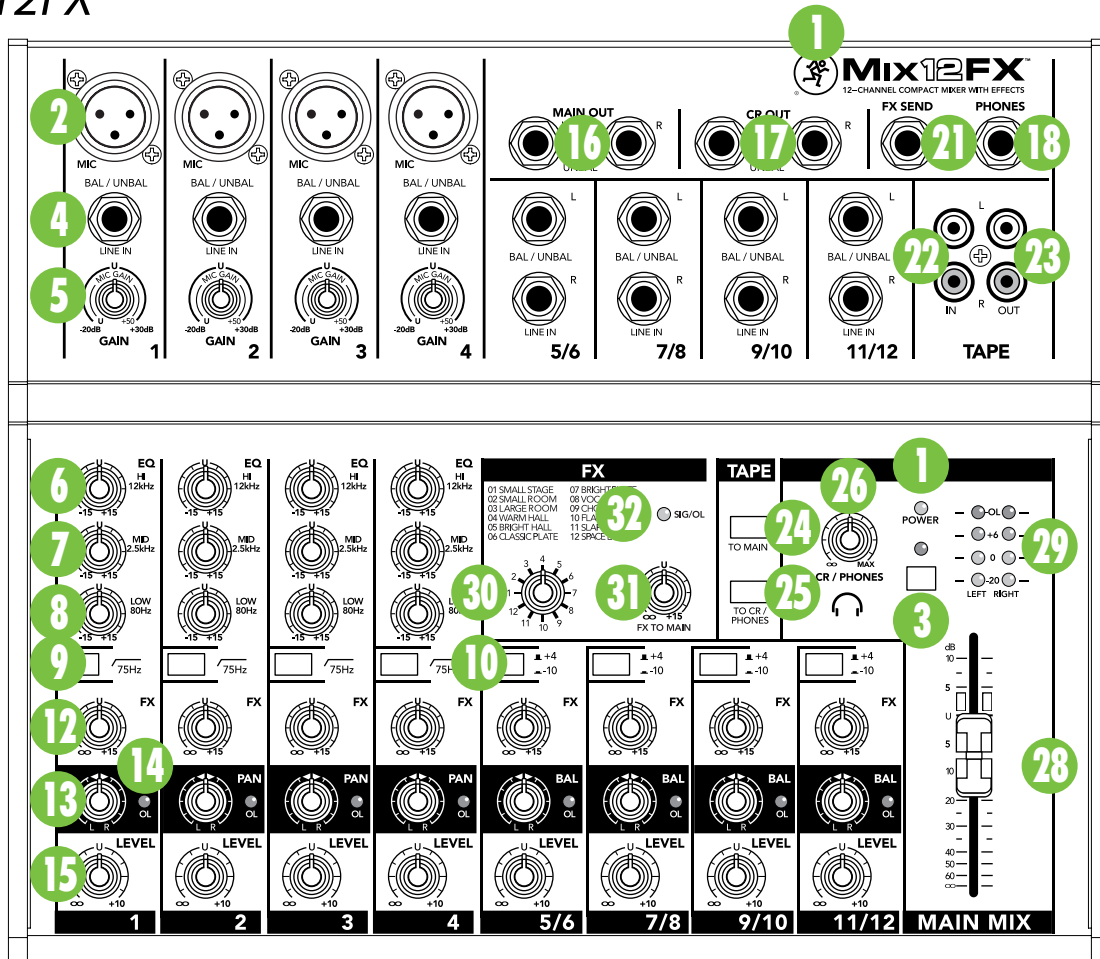



# Front and Rear Panel Features

At the risk of stating the obvious, this is where you plug everything in: power cord, microphones, line-level instruments and effects, headphones, and the ultimate destination for your sound: PA system, laptop, etc. All features described in this section are on top of the mixer, except for the power connector.

## 1. Power In and LED

This connection is where you connect the supplied external AC power supply to provide AC power to the mixer. Connect the external power supply to the Mix Series mixer first, then plug the power supply into a suitable and properly rated AC outlet. The mixer will turn on automatically when connected and the power LED will illuminate.

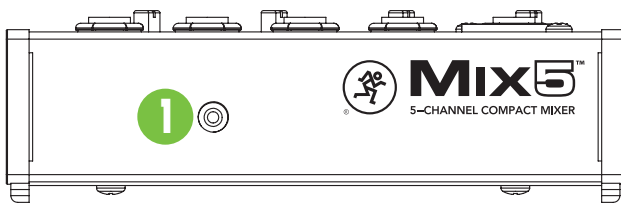

Make sure to use the correct external power supply.



Mix mixers feature varying power connectors based on country. Therefore, your power connector may (or may not) look different than the one displayed in the illustration above.

## 2. Mic Ins

This is a female XLR connector that accepts a balanced mic or line level input from almost any type of source. Be sure the cables are wired per AES (Audio Engineering Society) standards:

### Balanced XLR Input Connector

- Pin 1 – Shield (Ground)
- Pin 2 – Positive (+ or hot)
- Pin 3 – Negative (– or cold)

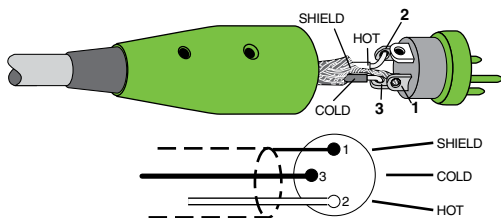

**Balanced XLR Input Connector**

Professional ribbon, dynamic, and condenser mics all sound excellent through these inputs. The mic/line inputs will handle any kind of level you can toss at them, without overloading.

Not every instrument is made to connect directly to a mixer. Guitars commonly need a Direct Injection (DI) box to connect to the mixer's mic inputs. These boxes convert unbalanced line-level signals from your guitar

into balanced mic-level outputs and provide signal and impedance matching. They also let you send your gifted guitar renditions over long cables or audio snakes, with minimum interference or high-frequency signal loss. Ask your dealer or guitar maker about their recommendations for a good DI box.

## 3. Phantom Power

Most modern professional condenser mics are equipped for phantom power, which lets the mixer send low-current DC voltage to the mic's electronics through the same wires that carry audio. (Semi-pro condenser mics often have batteries to accomplish the same thing.) “Phantom” owes its name to an ability to be “unseen” by dynamic mics (Shure SM57/SM58, for instance), which don't need external power and aren't affected by it anyway.

Phantom power on the Mix8 and Mix12FX is globally controlled by the phantom power switch. (This means the phantom power for all XLR inputs is turned on and off together.) The Mix5 XLR input always provides +15V.



Never plug single-ended (unbalanced) microphones, or ribbon mics into the mic input jacks of a Mix5 [always] or if the phantom power switch is engaged [Mix8, Mix12FX].



Do not plug instrument outputs into the mic input jacks with phantom power on unless you know for certain it is safe to do so.

## 4. Line Ins

These 1/4" jacks share circuitry (but not phantom power) with the mic preamps, and can be driven by balanced or unbalanced sources at almost any level. You can use these inputs for virtually any signal you'll come across since there is –20 to +30 dB of gain (50 dB range) available for line inputs via the gain knob. Always make sure to perform the level setting procedure on page 5.

TRS stands for Tip-Ring-Sleeve, the three connections available on a stereo 1/4" cable. This allows for a direct connection to the channel input jacks. Be sure the cables are wired per AES (Audio Engineering Society) standards:

### Balanced 1/4" TRS Connector

- Sleeve – Shield (Ground)
- Tip – Positive (+ or hot)
- Ring – Negative (– or cold)

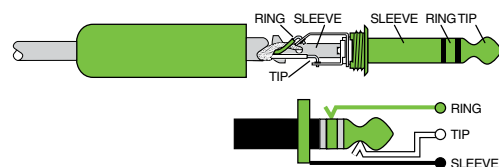

**Balanced 1/4" TRS Connector**

TS stands for Tip-Sleeve, the two connections available on a mono 1/4" cable. This allows for a direct connection to the channel input jacks. Be sure the cables are wired per AES (Audio Engineering Society) standards:

**Unbalanced 1/4" TS Connector**

Sleeve – Shield (Ground)  
Tip – Positive (+ or hot)

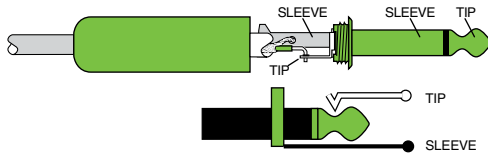

*Unbalanced 1/4" TS Connector*

**5. Gain**

These controls are found along the top row of knobs in the channel strip section. Gain adjusts the input sensitivity of the mic and line inputs. This allows signals from the outside world to be adjusted to optimal internal operating levels.

If the signal originates through the XLR jack, there will be 0 dB of gain with the knob fully down, ramping to 50 dB of gain fully up.

Through the 1/4" input, there is 20 dB of attenuation fully down and 30 dB of gain fully up, with a "U" (unity gain) mark at 12:00. This 20 dB of attenuation can be very handy when you are inserting a very hot signal, or when you want to add a lot of EQ gain, or both. Without this "virtual pad," this scenario might lead to channel clipping.

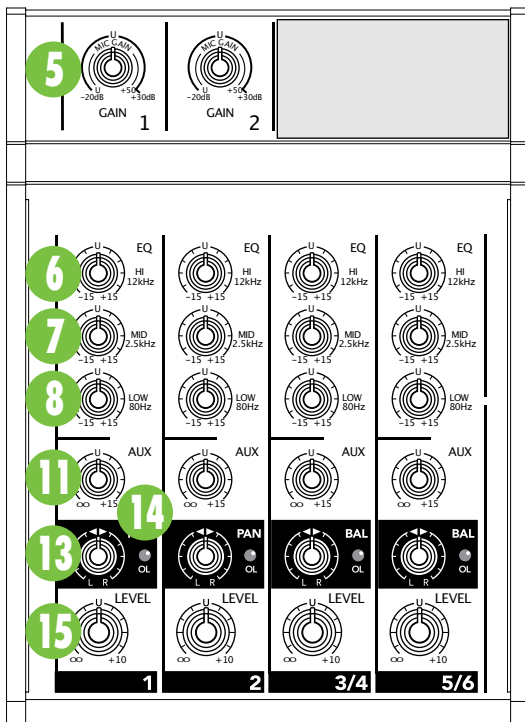

**2- and 3-Band EQ**

Mix Series mixers have 2- and 3-band equalization at carefully selected points — low shelving at 80 Hz, mid peaking at 2.5 kHz, and high shelving at 12 kHz. "Shelving" means that the circuitry boosts or cuts all frequencies before or past the specified frequency. For example, rotating the low EQ knob 15 dB to the right will boost the bass at 80 Hz and lower, down to the lowest note you never heard. "Peaking" means that certain frequencies form a "hill" around the center frequency — 2.5 kHz in the case of the mid EQ.

**6. Hi EQ**

This control gives you up to 15 dB boost or cut above 12 kHz, and it is also flat at the detent. Use it to add sizzle to cymbals, and an overall sense of transparency, or edge to keyboards, vocals, guitar and bacon frying. Turn it down a little to reduce sibilance, or to hide tape hiss.

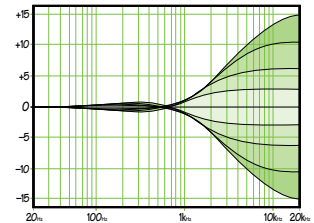

*High EQ*

**7. Mid EQ [Mix8 and Mix12FX only]**

Short for "midrange," this knob provides 15 dB of boost or cut, centered at 2.5 kHz, also flat at the center detent. Midrange EQ is often thought of as the most dynamic, because the frequencies that define any particular sound are almost always found in this range. You can create many interesting and useful EQ changes by turning this knob down as well as up.

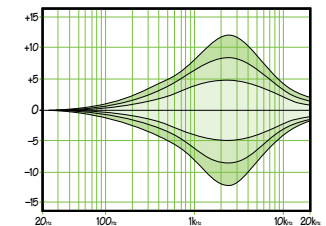

*Mid EQ*

**8. Low EQ**

This control gives you up to 15 dB boost or cut below 80 Hz. The circuit is flat (no boost or cut) at the center detent position. This frequency represents the punch in bass drums, bass guitar, fat synth patches, and some really serious male singers.

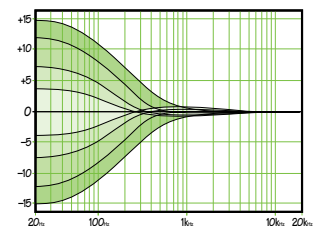

*Low EQ*

Used in conjunction with the Mix12FX's low cut switch, you can boost the low EQ without injecting a ton of subsonic debris into the mix.

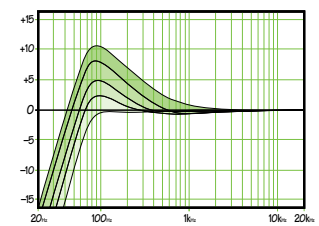

*Low EQ with Low Cut*

## Moderation During EQ

With EQ, you can also upset things royally. We've designed a lot of boost and cut into each equalizer circuit, because we know everyone will occasionally need that. But if you max the EQs on every channel, you'll get mix mush. Equalize subtly and use the left sides of the knobs (cut), as well as the right (boost). Very few multi-platinum-record-album engineers ever use more than about 3 dB of EQ. If you need more than that, there's usually a better way to get it, such as placing a mic differently (or using a different kind of mic or singer entirely).

## 9. Low Cut Switch [Mix12FX only, channels 1–4]

Each low-cut switch, often referred to as a high-pass filter (all depends on how you look at it), cuts bass frequencies below 75 Hz at a rate of 18 dB per octave.

We recommend that you use low-cut on every microphone application except kick drum, bass guitar, or bassy synth patches. These aside, there isn't much down there that you want to hear, and filtering it out makes the low stuff you do want much more crisp and tasty. Not only that, but low-cut can help reduce the possibility of feedback in live situations, and it helps to conserve amplifier power.

Another way to consider low-cut's function is that it actually adds flexibility during live performances. With the addition of low-cut, you can safely use low equalization on vocals. Many times, bass shelving EQ can really benefit voices. Trouble is, adding low EQ also boosts stage rumble, mic handling clunks and breath pops. Applying low-cut removes all those problems, so you can add low EQ without losing a woofer.

## 10. +4 / -10 Switch [Mix12FX only, channels 5/6 – 11/12]

This two position switch sets the input level of the channel 5/6 – 11/12 inputs to either +4 dB (balanced input, switch disengaged) or -10 dB (unbalanced input, switch engaged). Use the +4 dB setting for professional equipment operating at the +4 dBu standard and use the -10 dB setting for consumer equipment operating at the -10 dBV standard.

## 11. Aux [Mix8 only]

These knobs allow you to tap a portion of each channel's signal out to another source for parallel effects processing or stage monitoring. Aux send levels are controlled by these knobs and by the aux master.

These are more than just effects and monitor sends. They can be used to generate separate mixes for recording or "mix-minuses" for broadcast, as well.

The aux send level ranges from off through unity (the center position) on up to 15 dB of extra gain (when turned fully clockwise). Chances are you'll never need this extra gain, but it's nice to know it's there if you do.

The channel 3/4–5/6 aux knobs control the mono sum of the channel's stereo signals for each aux send. For instance, channel 3 (L) and 4 (R) mix together to feed that channel's aux send knob.

Aux sends are post-fader. This way, when changes are made, the "wet" signal moves up and down along with the "dry" signal, maintaining a balance between them.

## 12. FX [Mix12FX only]

These knobs tap a portion of each channel's signal to set up a nice FX mix feeding the internal FX processor, and to feed external processors via the FX send.

The FX feed from stereo channels is a mono sum of the left and right sides of these channels.

The controls are off when turned fully down, deliver unity gain at the center detent, and can provide up to 15 dB of gain turned fully up.

The FX signal reaching the internal FX processor and the FX send output jack, is the sum (mix) of all the channels whose FX control is set to more than minimum. The FX signal from the internal FX processor is added to the main mix using the FX to main knob.

FX sends are post-fader. This way, when changes are

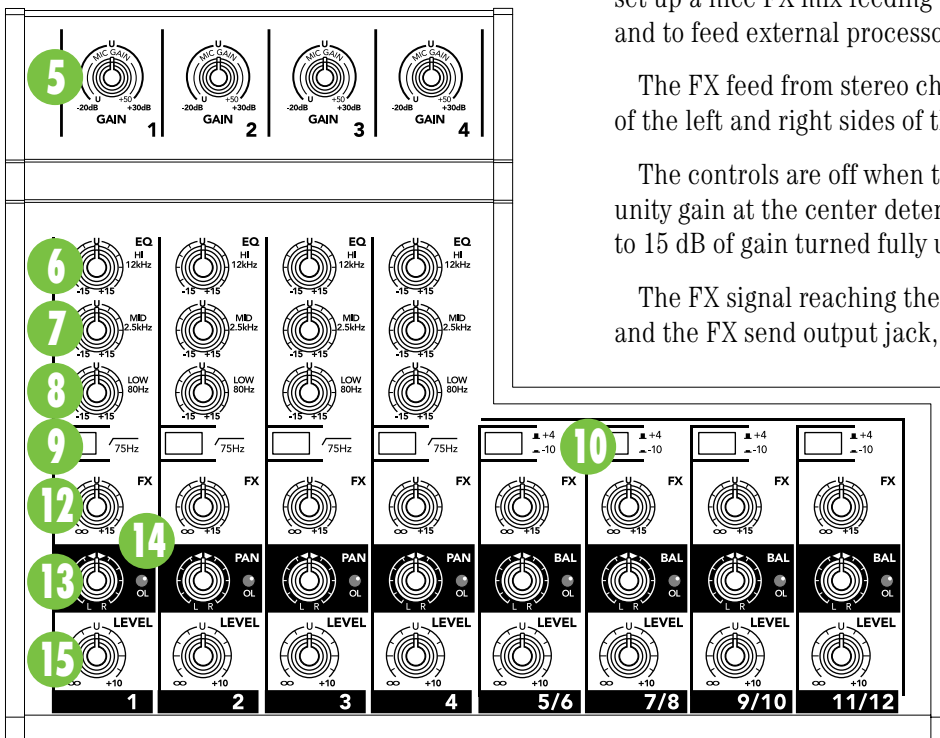

made, the “wet” signal moves up and down along with the “dry” signal, maintaining a balance between them.

There is more info about FX on pages 13 [FX send jack], 15 [preset select knob, FX to main knob, FX Sig/OL LED] and page 22 [table of effects presets].

### 13. Pan / Bal

Pan adjusts the amount of channel signal sent to the left versus the right outputs. On mono channels (with connections to the left input only) these controls act as pan pots. On stereo channels (with stereo connections to left and right inputs), the pan knob works like the balance control on a home stereo.

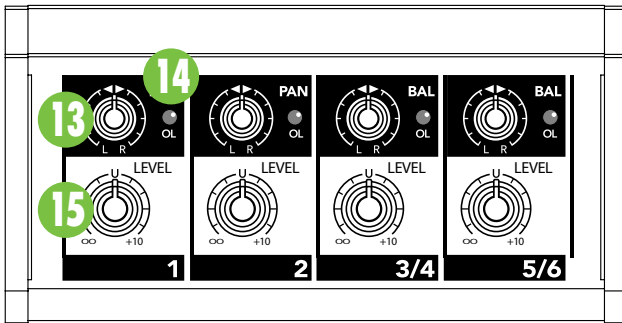

### 14. OL LEDs

This LED will illuminate red when the channel’s input signal is too high, indicating a signal overload. This should be avoided, as distortion will occur. If the OL LED comes on regularly, check that the gain knob is set correctly for the input device. The signal is at -3 dB before hard clip begins.

### 15. Level

This adjusts the channel’s level, from off, to unity gain at the center, on up to 10 dB of additional gain.

### 16. Main Out

These 1/4" TRS balanced/unbalanced outputs feed the main mix out into the waiting world. You may feed the amplifiers or powered speakers this way.

TRS stands for Tip-Ring-Sleeve, the three connections available on a stereo 1/4" cable. To use these outputs to drive balanced inputs, be sure the cables are wired per AES (Audio Engineering Society) standards:

#### Balanced 1/4" TRS Connector

- Sleeve – Shield (Ground)
- Tip – Positive (+ or hot)
- Ring – Negative (- or cold)

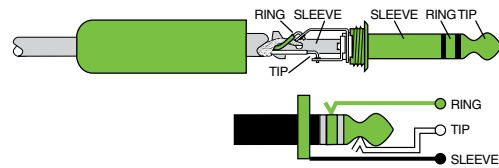

*Balanced 1/4" TRS Connector*

TS stands for Tip-Sleeve, the two connections available on a mono 1/4" cable. For most music recording and PA applications, unbalanced lines are fine. To drive unbalanced inputs, be sure the cables are wired per AES (Audio Engineering Society) standards:

#### Unbalanced 1/4" TS Connector

- Sleeve – Shield (Ground)
- Tip – Positive (+ or hot)

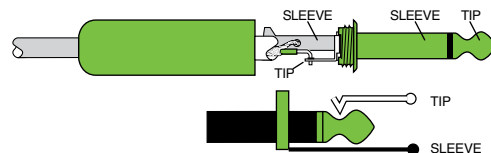

*Unbalanced 1/4" TS Connector*

### 17. CR Out [Control Room Output] [Mix8 and Mix12FX only]

These TRS 1/4" balanced/unbalanced outputs allow you to listen to something other than the main mix. These outputs are often used to run a nice pair of powered studio monitors in a control room or a headphone distribution amplifier. The volume is adjustable with the CR / phones knob.

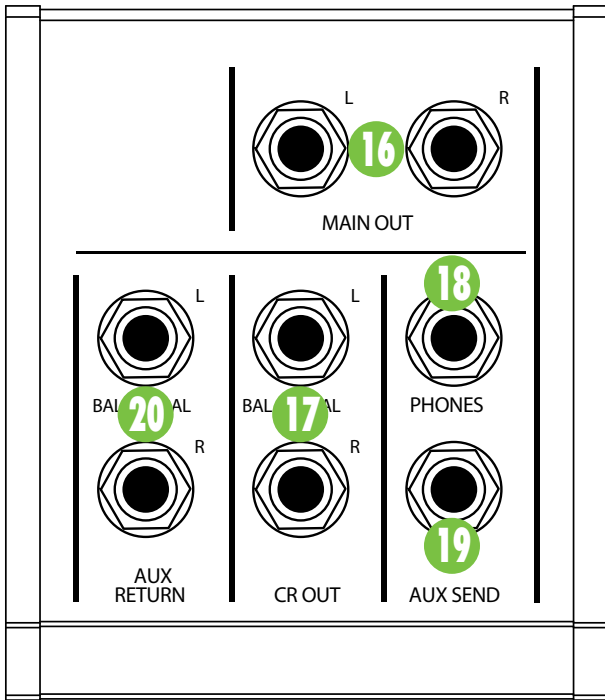

### 18. Phones Out

This stereo jack will drive any standard headphone to very loud levels. "iPod"-type and computer headphones may also be used here, with a 1/4" male to 1/8" female stereo adapter.

The level is adjusted with the CR / phones knob. If you're wiring your own cable for the phones output, follow standard AES (Audio Engineering Society) conventions:

#### Unbalanced 1/4" TRS Connector

- Sleeve – Shield (Ground)
- Tip – Left Channel
- Ring – Right Channel

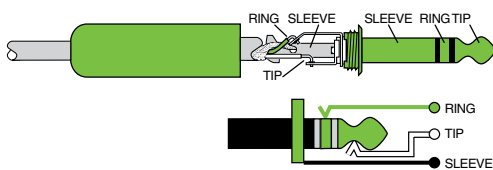

*Unbalanced 1/4" TRS Connector*



**WARNING:** The headphone amp is loud, and can cause permanent ear damage.

Even intermediate levels may be painfully loud with some earphones. **BE CAREFUL!** Always turn the CR / phones knob all the way down before connecting headphones. Keep it down until you've put the phones on. Then turn it up slowly. Why? "Engineers who fry their ears find themselves with short careers."

### 19. Aux Send [Mix8 only]

This is a TRS 1/4" balanced/unbalanced output, commonly used to feed stage monitors or an external effects processor.

The aux send knobs tap a portion of each channel's signal to provide an output here, allowing you to set up a nice stage monitor mix, or to set up an external effect from different channels.

Aux sends are post-fader. This way, when changes are made, the "wet" signal moves up and down along with the "dry" signal, maintaining a balance between them.

### 20. Aux Return [Mix8 only]

This is where you connect the outputs of your parallel effects devices. They can also be used as an extra pair of stereo line inputs (i.e. channel 7/8, hence the name "Mix8") if you have a lot of synths, for example. The circuits will handle stereo or mono, balanced or unbalanced signals. They can be used with just about any pro or semipro effects device on the market.



### 21. FX Send [Mix12FX only]

This 1/4" TRS line-level output may be used to feed an external effects processor (FX), such as a nice sound effect or delay unit. The output from this jack is an exact copy of what goes into the internal FX processor, being the careful mix of all channels whose FX control is turned to more than minimum.

(The processed output of the internal FX does not come out of this output, but is added internally to the main mix.)

The overall output level may be adjusted with the FX to main knob. (This knob also affects the level going into the internal FX.)

The output is "post-fader," – or in this case, "post-knob" – so any changes to the channel level knobs will also affect the level going to the external processor.

The processed output from the effects processor is usually returned to a spare channel where you may carefully mix the original unprocessed channel (dry) and the processed channel (wet). Altering the original channel level knob increases both the wet and dry signals and keeps them at the same delicate ratio. (For example, the reverb remains at the same level relative to the signal source.)

## 22. Tape In

Connect computer audio outputs, or tape recorder's outputs here, using standard hi-fi (RCA) cables.

Use these jacks for convenient playback of your mixes. You'll be able to review a mix then try another pass without repatching or disturbing the mixer levels. You can also use these jacks with an MP3 player, CD player or laptop to feed music to a PA system between sets.

RCA plugs are unbalanced. Connect the signal to the center post and the ground (earth) or shield to the surrounding "basket." Be sure the cables are wired per AES (Audio Engineering Society) standards:

### Unbalanced RCA Connector

Sleeve – Shield (Ground)  
Tip – Positive (+ or hot)

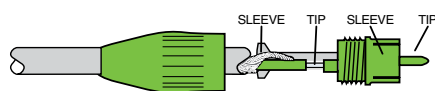

Unbalanced RCA Connector

## 23. Tape Out

Unbalanced RCA connections tap the main mix output to make simultaneous recording and PA work more convenient. Connect these to your laptop or standalone recorder's inputs.

**Mono Out:** If you want to feed a mono signal to your standalone recorder or other device, simply use a stereo RCA to mono 1/8" cord to combine these outputs. Do not attempt this with any other outputs on a Mix Series mixer.

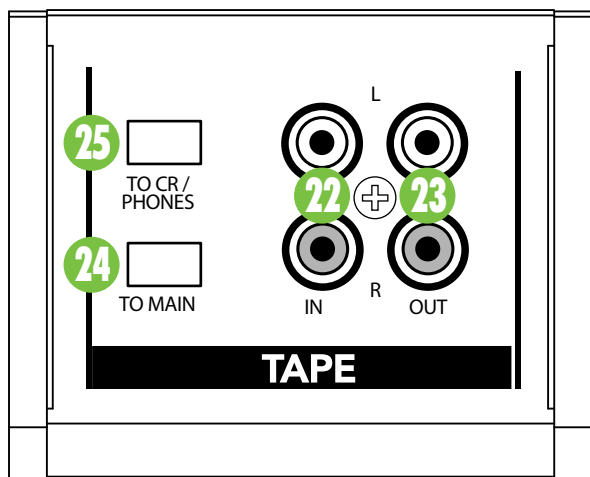

## 24. Tape to Main

Push this button in to route the tape in signal to the main mix.



**WARNING:** Pushing in the tape to main button may create a feedback path between tape in and tape out. Make sure the tape deck is not in record mode, record-pause mode, or input monitor mode before this switch is engaged.

## 25. Tape to CR / Phones

Push this button in to route the tape in signal to the control room and phones. When the switch is up [disengaged], the control room, phones and meters receive the main mix signal tapped after the main mix control.

When the switch is down [engaged], the control room, phones and meters receive the MP3/CD/tape input signal. This is especially useful for auditioning or cueing up house music to play in between sets.



**WARNING:** Turn down the control room / phones knob before engaging this switch.

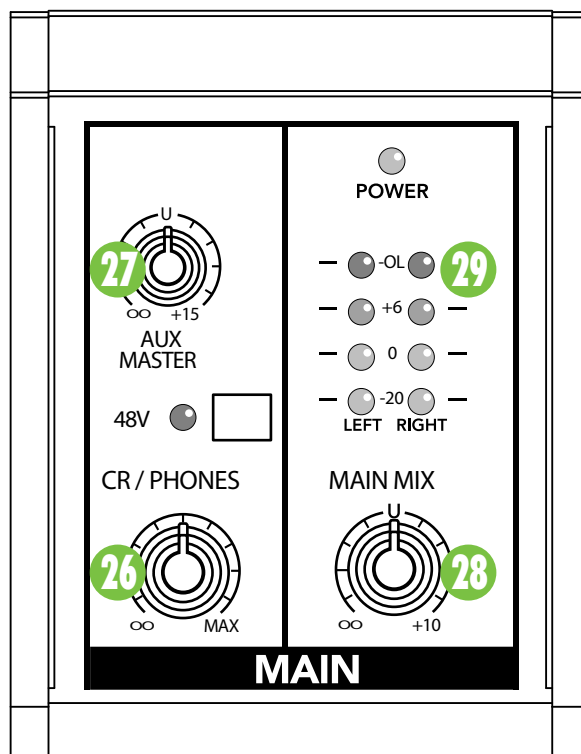

## 26. CR / Phones

As you might expect, this knob controls the levels of both the stereo control room and the headphones outputs. Make sure that you move it to minimum before adding a new source.

Whatever your selection, you can also use the control room outputs for other applications. The sound quality is just as impeccable as the main outputs. It can be used as an additional main mix output and this one will have its own level control.

## 27. Aux Master [Mix8 only]

This knob provides overall level control of the aux send, just before it's delivered to the aux send output. This knob goes from off (turned fully down), to unity gain at the center, with 15 dB of extra gain (turned fully up). You may never need the additional gain, but here it is anyway.

## 28. Main Mix

This knob controls the levels of signals sent to the main and tape outputs. All channels and aux returns that are not turned fully down will wind up in the main mix.

Fully counterclockwise is off, the center is unity gain, and fully clockwise provides 10 dB of additional gain. This additional gain will typically never be needed, but once again, it's nice to know it's there. This is the knob to turn down at the end of the song when you want "The Great Fade-Out."



**NOTE:** Mix12FX users, you probably noticed that there is no main mix knob, but rather a main mix fader. It works exactly the same as listed above except you raise and lower the fader. Trying to turn it clockwise and counterclockwise would be counterintuitive to what you are trying to accomplish. It would damage the mixer, too, and you don't want that!

## 29. Meters

Mix Series mixers peak metering system – say that five times fast! – should be made up of two columns of four LEDs. If you happen to see more than that, post a picture to Instagram and/or Twitter with the hashtag #LEDsGalore. The threshold ranges from -20 dBu on up to +18 dBu (OL = overload).

The 0 dB LED corresponds to an output level of 0 dBu (0.775 V RMS). The OL LEDs illuminate when the output reaches +18 dBu. There is a fair margin of safety before actual clipping distortion occurs, but turn things down if the OL LEDs illuminate.

The meters typically display the level of the main mix after the main mix level. However, if the tape to control room / phones switch is engaged, the meters will display that level instead of the main mix.

You can get a good mix with peaks flashing anywhere between -20 and +6 dB on the meter display. Most amplifiers clip at about +10 dB, and some recorders aren't so forgiving either. For best real-world results, try to keep peaks between "0" and "+6."

If the meters are too high, there will be distortion. If they are too low, the signal-to-noise ratio will suffer. Use the meters to help adjust the mixer for optimum performance without distortion or noise. Then adjust the amplifier's level controls for good overall volume. The result: the best overall signal-to-noise ratio!

Please remember: Audio meter displays are just tools to help assure you that your levels are "in the ballpark." You don't have to stare at them (unless you want to). If you find that staring at the meters sends you into a hypnotic trance, please do not be alarmed. Just mow my lawn and polish my car every Tuesday.

## FX [Mix12FX only]

The Mix12FX features an internal effects processor with 12 presets. Signals to this effects processor comes from adjusting the FX send on each channel. The output from the processor may be added to the main mix by adjusting the FX to main knob.

Very careful thought and lots of audio love has gone into the design of the 12 presets. The engineers spent a lot of time lounging about in warm halls, visiting bright halls and small stages and going to concerts just to get these sounds right for you. Initially, they wanted to investigate "warm beach in Hawaii," but had to make do with "cold forest in Washington" instead...

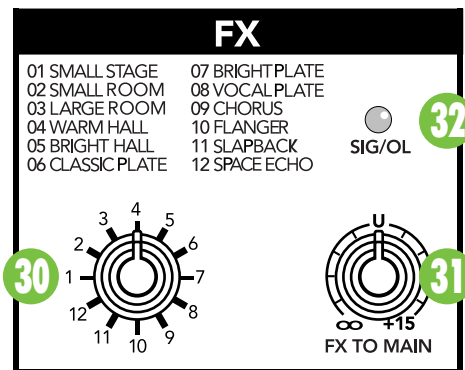

### 30. Preset Select [Mix12FX only]

Rotate this detented switch to select the desired preset effect.

Please refer to Appendix C: Table of Effects Presets on page 22 for more details about the presets and examples.

### 31. FX to Main [Mix12FX only]

Signals from the internal effects (FX) processor make their way through this knob and continue on to the main mix fader. They contain the effects' "wet" signals and are mixed together with the channels' "dry" original signals. Turned fully up, it provides 15 dB of additional gain, the center "U" mark is unity gain, and fully down is off.

### 32. FX Sig / OL LED [Mix12FX only]

This dual-colored LED will illuminate green when the FX signal is present, indicating FX signal. It will remain lit so long as there is an FX signal above -20 dBu.

This dual-colored LED will illuminate red when the FX signal is too high, indicating a signal overload. This should be avoided, as distortion will occur. If the OL LED comes on regularly, check that each channel's FX knob is set correctly for the input device and/or turn the FX to main knob down.

# Appendix A: Service Information

## Warranty Service

If you think your Mix Series mixer has a problem, please check out the following troubleshooting tips and do your best to confirm the problem. Visit the Support section of our website ([www.720trees.com](http://www.720trees.com)) where you will find lots of useful information such as FAQs and other documentation. You may find the answer to the problem without having to send your mixer away.

## Troubleshooting

### Power

- Our favorite question: is the power switch on? Ha, fooled you! There is no power switch!
- Is the external power supply securely plugged into the power connector on the back of the Mix Series mixer?
- Is the external power supply securely plugged into an AC power strip? Make sure the power to the power strip is turned on.
- Are all the lights out in the building?

### Bad Channel

- Is the gain set correctly?
- Is the level knob turned up?
- Try the same source signal in another channel, set up exactly like the suspect channel.
- Check that the pan knob is set correctly.
- Check the EQ and the low-cut switch.

### Bad Output

- Is the associated level knob (if any) turned up?
- If it's one of the main outs, try unplugging all the others. For example, if it's the left main out, unplug the RCA and CR left outputs. If the problem goes away, it's not the mixer.
- If a left speaker is presumed dead, switch the left and right cords, at the mixer's main outs. If the left speaker is still not working, it's not the mixer.

### Noise

- Turn the channel level and aux return knobs down, one by one. If the sound disappears, it's either that channel or whatever is plugged into it, so unplug whatever that is. If the noise disappears, it's from your whatever.

## Repair

For warranty service, refer to the warranty information on page 23.

Non-warranty service is available at a factory-authorized service center. To locate the nearest service center, visit [www.720trees.com](http://www.720trees.com), click "Contact Tech Support" and select "Locate a Service Center or Distributor" [3]. Service for a Mix Series mixer living outside the United States may be obtained through local dealers or distributors.

If you do not have access to our website, you can call our Tech Support department at 1-800-898-3211, Monday-Friday, normal business hours, Pacific Time, to explain the problem. Tech Support will tell you where the nearest factory-authorized service center is located in your area.



# Appendix B: Technical Information

## Specifications

### Noise Characteristics

(20 Hz – 20 kHz bandwidth, 150 $\Omega$ source impedance, EIN)	
All outputs, master levels and channel levels off	-100 dBu
All outputs, master levels unity, all channel levels off	-90 dBu
All outputs, master levels unity, 1 channel level unity	-85 dBu

### Distortion (THD+N)

(20 Hz – 20 kHz bandwidth)	
Mic Input to Main Output	<0.01% @+4 dBu output

### Attenuation and Crosstalk

(20 Hz – 20 kHz bandwidth)	
Inputs to Outputs @1 kHz	-90 dBu
Main Mix Off @1 kHz	-82 dBu

### Frequency Response

Mic Input to Any Output (Gain at Unity)	
	+0, -1 dB, 20 Hz to 30 kHz

### Equivalent Input Noise (EIN)

(Mic in to Insert Send out, max gain.)	
150 $\Omega$ termination	-125 dBu [Mix5, Mix8] -122 dBu [Mix12FX]

### Common Mode Rejection Ratio (CMRR)

(Mic in to Insert Send out, max gain.)	
1 kHz	better than -70 dB

### Maximum Levels

All inputs	+25 dBu
Main output	+25 dBu
All other outputs	+26 dBu

### Impedances

Mic in	2 k $\Omega$ [Mix5] 3.8 k $\Omega$ [Mix8, Mix12FX]
All other inputs	10 k $\Omega$ or greater
Tape out	1 k $\Omega$
Phones	22 $\Omega$
All other outputs	120 $\Omega$ unbalanced, 240 $\Omega$ balanced

### EQ

High Shelving	$\pm 15$ dB @ 12 kHz
Mid Peaking	$\pm 15$ dB @ 2.5 kHz
Low Shelving	$\pm 15$ dB @ 80 Hz
Low Cut Filter	18 dB/octave, -3 dB @ 75 Hz

### Power Requirements

Power Connection	2-pin DC connector [US] 3-pin DC connector [EU]
Input	120 VAC, 60 Hz [US] 230 VAC, 50/60 Hz [EU]
Output	18 VAC, 600mA [Mix5, Mix8] 18 VAC, 1000mA [Mix12FX]

### Dimensions (H x W x D)

Mix5	Height	1.7" / 43 mm
	Width	5.5" / 140 mm
	Depth	7.7" / 196 mm
Mix8	Height	2.1" / 53 mm
	Width	7.8" / 198 mm
	Depth	9.6" / 244 mm
Mix12FX	Height	2.1" / 53 mm
	Width	11.7" / 297 mm
	Depth	9.6" / 244 mm

### Weight

Mix5	1.4 lb / 0.6 kg
Mix8	2.5 lb / 1.1 kg
Mix12FX	3.7 lb / 1.7 kg

Since we are always striving to improve our products by incorporating new and improved materials, components, and manufacturing methods, we reserve the right to change these specifications at any time without notice.

The "Running Man" figure is a registered trademark of LOUD Technologies Inc. All other brand names mentioned are trademarks or registered trademarks of their respective holders, and are hereby acknowledged.

Please check our website for any updates to this manual: [www.720trees.com](http://www.720trees.com). Batteries not included.

©2014 LOUD Technologies Inc. All Rights Reserved.

## Dimensions

### Mix5

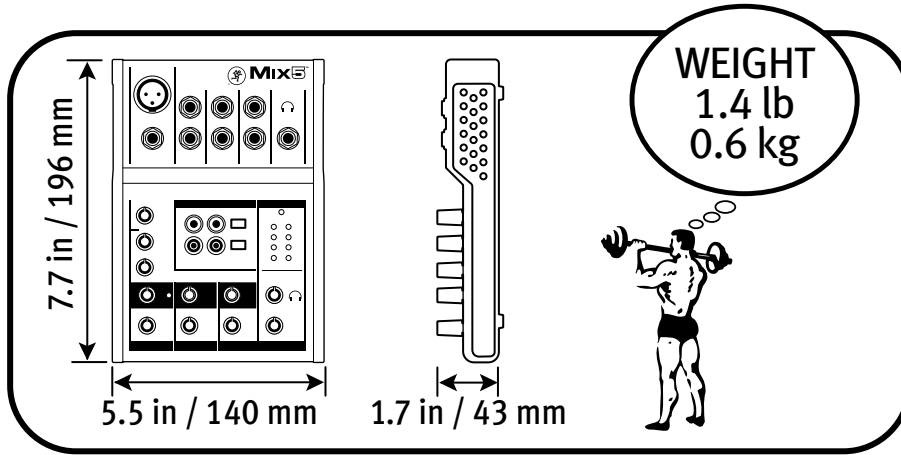

### Mix8

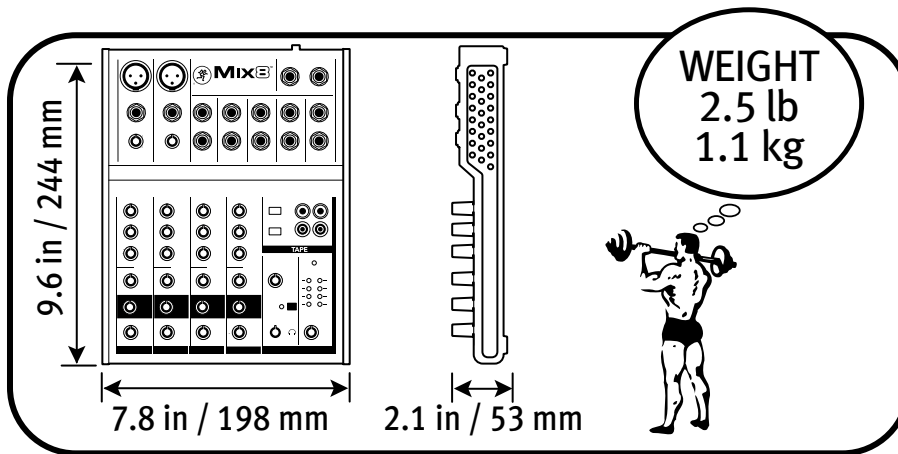

### Mix12FX

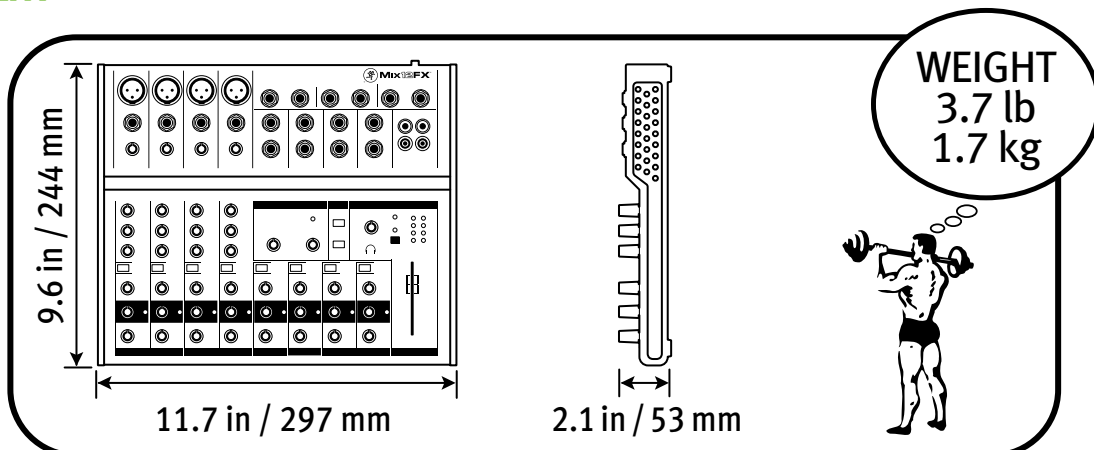

# Mix5 Block Diagram

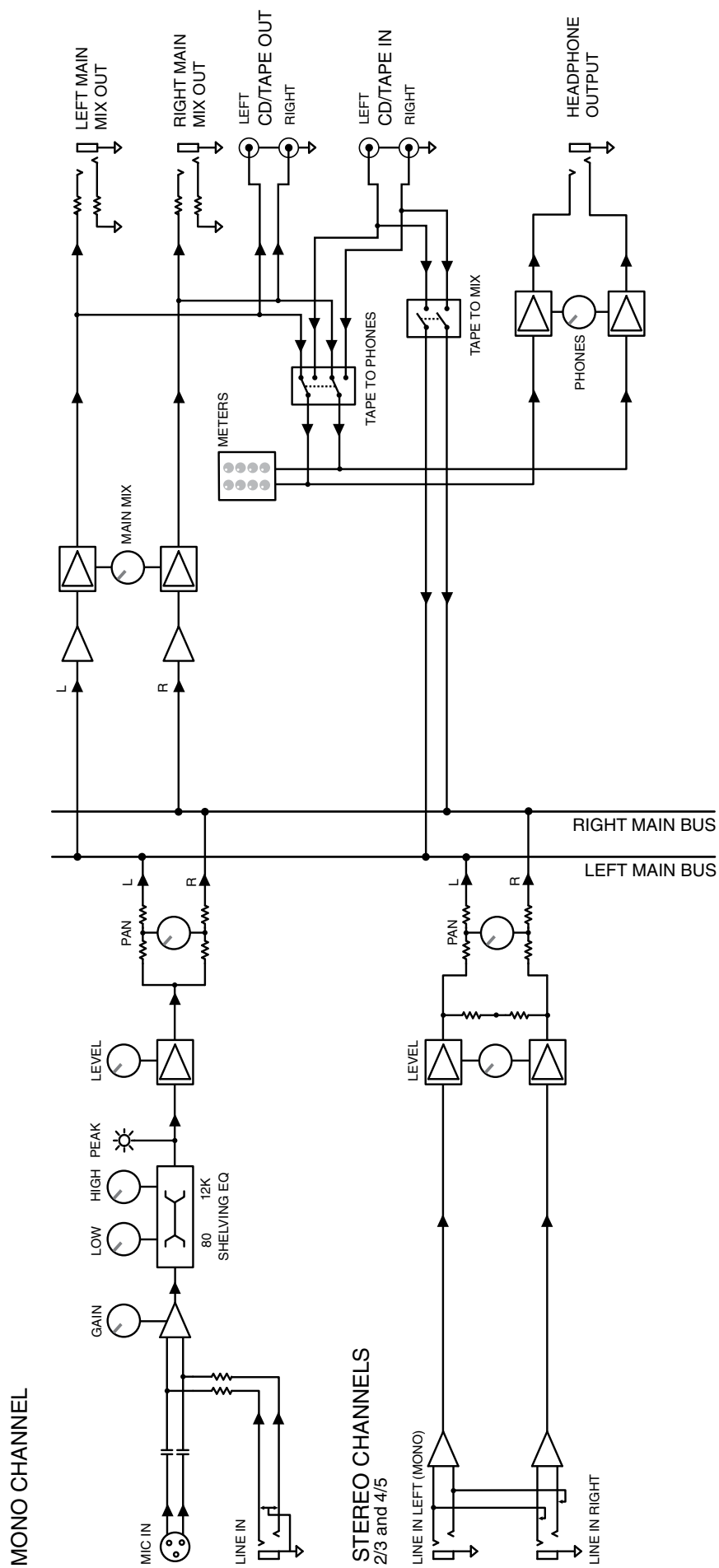

# Mix8 Block Diagram

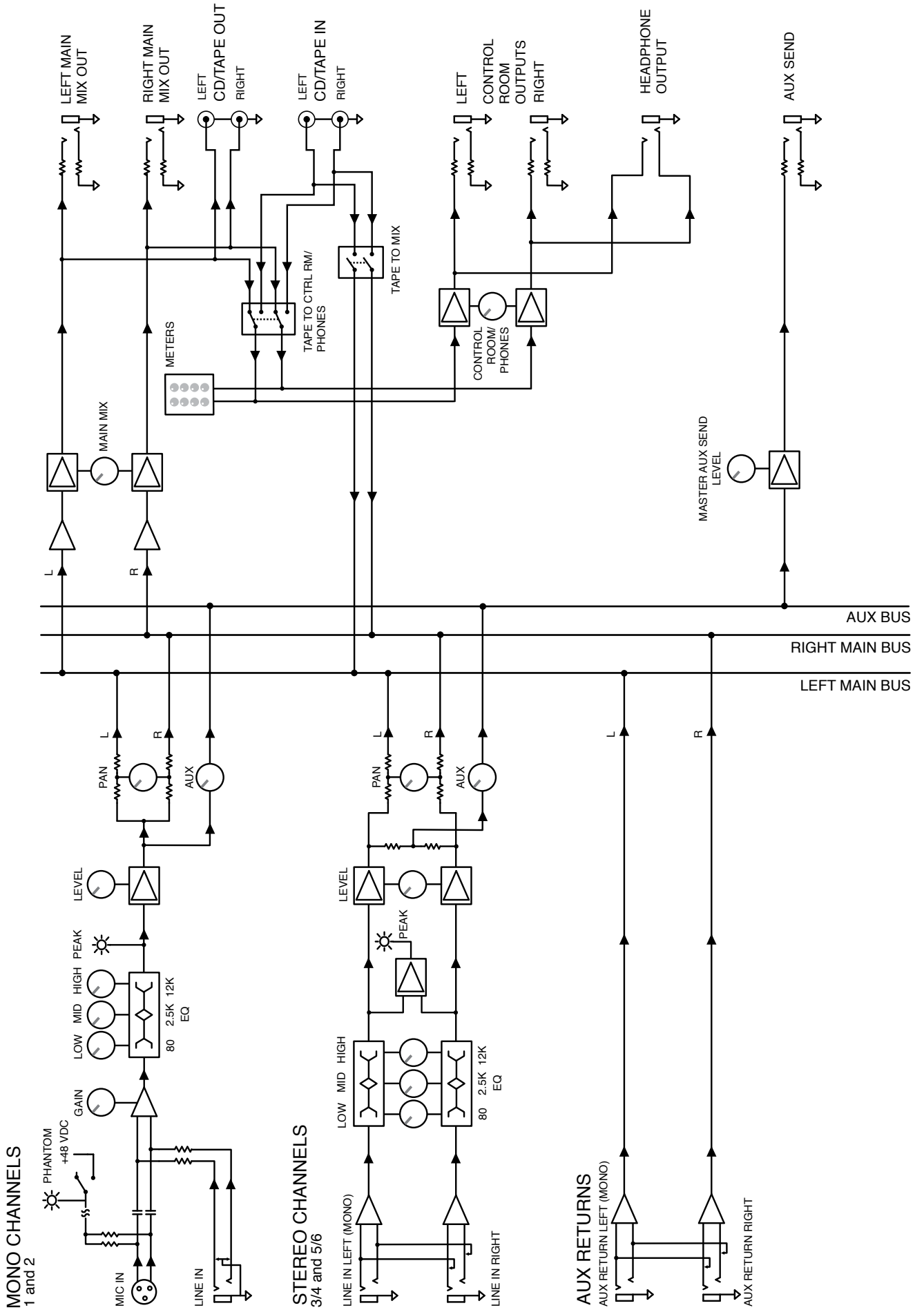

# Mix 12FX Block Diagram

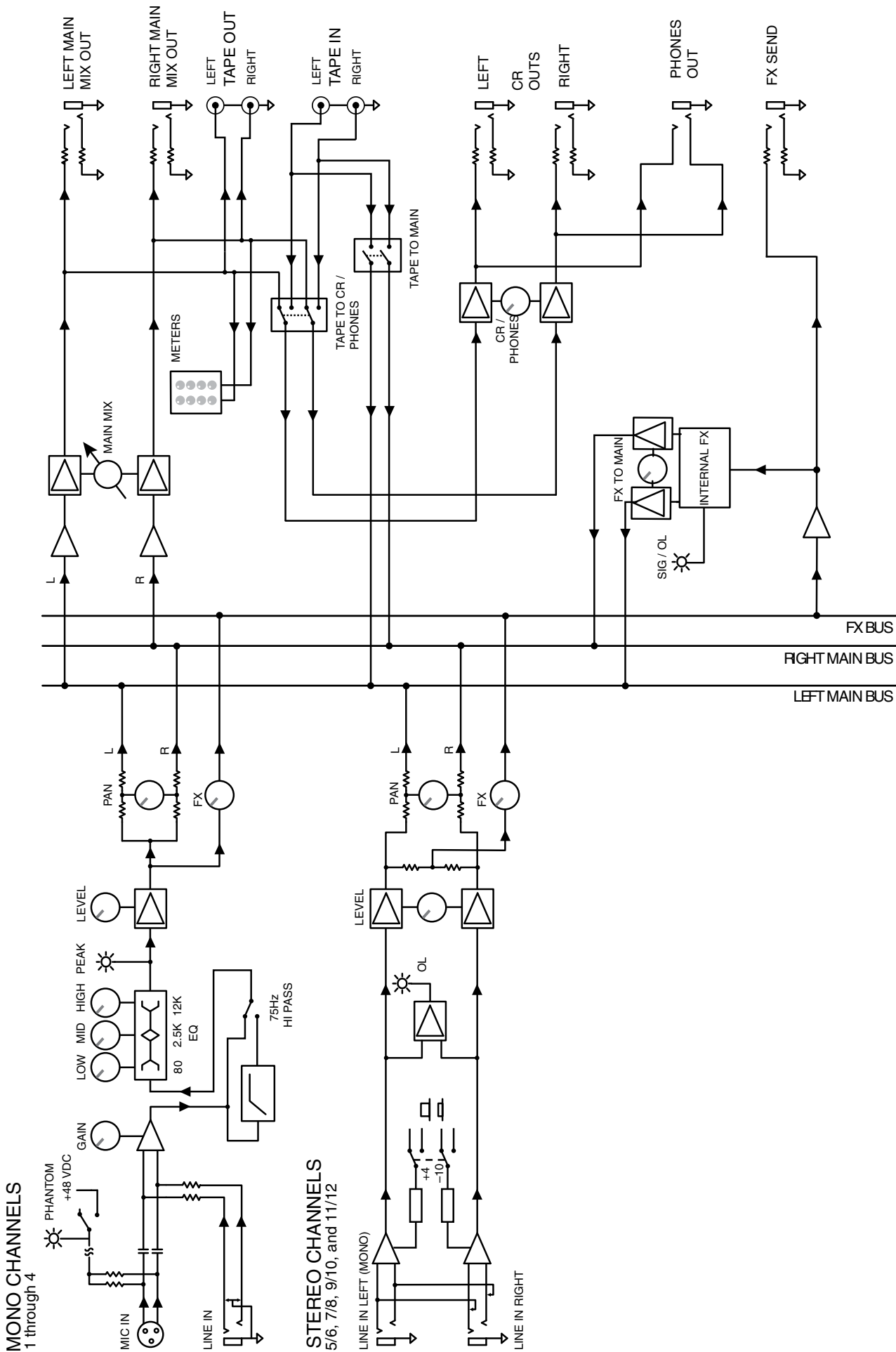

# Appendix C: Table of Effects Presets

No.	Title	Description	Example of its use
01	Small Stage	This preset simulates the sound of a small concert stage, with a short reverb time and reverberant space.	Useful for vocals or guitars in fast paced, high-energy songs that call for a "live" sounding reverberation.
02	Small Room	The small room reverb simulates the reverberation (persistence of sound) in a typical small room. Small rooms are typically coined "dead" rooms with little to no reverb.	Some artists record guitars (and/or bass) from a bathroom to get a "punchier" sound out of their amp.
03	Large Room	The large room reverb simulates the reverberation (persistence of sound) in a typical large room. Large rooms are typically coined "live" rooms since they have a lot of reverb.	Sound tends to carry in large rooms with a lot of open space. This works well for a good, boomy kick sound.
04	Warm Hall	This reverb simulates the sound of a spacious, yet cozy, heavily draped and carpeted concert hall with an especially warm tone.	Perfect for adding natural concert hall ambience to close-mic'ed orchestral instruments.
05	Bright Hall	This reverb is characterized by its large, spacious sound, long pre-delay and vibrant tone. It has a bright tone with lots of scattered reflections to simulate harder, more reflective surfaces.	Useful on vocals that require a brighter reverb to cut through the mix, or for giving acoustic instruments a livelier vibe.
06	Classic Plate	This preset emulates vintage mechanical reverberation that was generated with a metal plate. Its sound is characterized by lots of early reflections and no pre-delay.	Perfect for thickening percussive instruments, such as a snare drum, or tight vocal arrangements.
07	Bright Plate	More than just a shiny object, the bright plate is a fast-acting, airy reverb that scoops the lows out of a standard or classic plate reverb.	Excellent for midrange instruments such as acoustic guitars, or percussion such as snares and toms.
08	Vocal Plate	This vintage plate emulation is warmer than your standard plate, with a long reverberant tail, lots of fast reflections and a very short pre-delay.	Particularly suited for vocal signals, but can also be used for extra-thick drum tracks.
09	Chorus	This preset provides a soft, ethereal sweeping effect that is useful for thickening and for making a particular sound pop out of the mix.	Perfect for enhancement of electric and acoustic guitar and bass, or to add a dramatic effect to vocals, particularly group harmonies and choirs.
10	Flanger	The flanger creates a strong sweeping effect, useful for thickening and for making a particular sound really pop.	This effect is particularly effective on electric guitars (rhythm and lead) in rock 'n roll.
11	Slapback	This effect encompasses a longer delay time with little to no feedback.	Slapback is typically used to capture the vocal sound heard on rock 'n roll records from the 1950s, although it's used on drums and other percussion, as well.
12	Space Echo	A long-lasting, repetitive delay. We may title it the "Space Echo", but around the office it's known as Greg's Outstanding Long-lasting Delay, or GOLD!	The entirety of Radiohead's <i>OK Computer</i> album (which, hey, won a Grammy Award for Best Alternative Music Performance in 1998).

# Limited Warranty

## **Please keep your sales receipt in a safe place.**

This Limited Product Warranty ("Product Warranty") is provided by LOUD Technologies Inc. ("LOUD") and is applicable to products purchased in the United States or Canada through a LOUD-authorized reseller or dealer. The Product Warranty will not extend to anyone other than the original purchaser of the product (hereinafter, "Customer," "you" or "your").

For products purchased outside the U.S. or Canada, please visit [www.720trees.com](http://www.720trees.com) to find contact information for your local distributor, and information on any warranty coverage provided by the distributor in your local market.

LOUD warrants to Customer that the product will be free from defects in materials and workmanship under normal use during the Warranty Period. If the product fails to conform to the warranty then LOUD or its authorized service representative will at its option, either repair or replace any such nonconforming product, provided that Customer gives notice of the noncompliance within the Warranty Period to the Company at: [www.720trees.com](http://www.720trees.com) or by calling LOUD technical support at 1.800.898.3211 (toll-free in the U.S. and Canada) during normal business hours Pacific Time, excluding weekends or LOUD holidays. Please retain the original dated sales receipt as evidence of the date of purchase. You will need it to obtain any warranty service.

For full terms and conditions, as well as the specific duration of the Warranty for this product, please visit [www.720trees.com](http://www.720trees.com).

The Product Warranty, together with your invoice or receipt, and the terms and conditions located at [www.720trees.com](http://www.720trees.com) constitutes the entire agreement, and supersedes any and all prior agreements between LOUD and Customer related to the subject matter hereof. No amendment, modification or waiver of any of the provisions of this Product Warranty will be valid unless set forth in a written instrument signed by the party to be bound thereby.



---

**16220 Wood-Red Road NE**  
**Woodinville, WA 98072 • USA**  
**Phone: 425.487.4333**  
**Toll-free: 800.898.3211**  
**Fax: 425.487.4337**  
**[www.720trees.com](http://www.720trees.com)**

---