



Reliable Digital Security Products

LBVF-856WFL

- 4-IN-1 AHD/CVI/TVI/CVBS
- **2Mp/4Mp/5Mp** HD Video Out
- Manual Varifocal Lens 2.8-12mm
- 60M Night Vision
- IP67 WaterProof



Camera	
Image Sensor	1/3" CMOS Sensor
Image Resolution	5Mp (2592x1944), 4Mp (2560x1440), 2Mp (1920x1080)
Video Output Mode	AHD/TVI : 5Mp@20fps/12.5fps, 4Mp@30fps, 2Mp@30fps; CVI : 4Mp@30fps, 2M@30fps
Electronic Shutter	AUTO
TV System	PAL/NTSC
Scanning System	Progressive Scan
Lens	
Focus Length	Board Lens 2.8-12mm
Focus Control	Manual
Lens Type	Manual
Night Vision	
IR Cut Filter	YES
Infrared LED	42μ x 6PCS
Infrared Distance	60M
IR Status	AGC Auto Control
Camera Features	
Starlight	/
Day/Night	YES
OSD Menu Language	YES
White Balance	AUTO / MANUAL
Gain Control	AUTO
Noise Reduction	DNR
WDR	DWDR
UTC	YES

General	
Housing	IP67
Bracket	YES
Operation Temperature	-10°C ~ +60°C RH95% Max
Storage Temperature	-20°C ~ +60°C RH95% Max
Power Source	DC12V±10%,950mA
Dimension	211(W) x 92(H) x 90(D)mm
Weight	1.4Kg

Dimensions

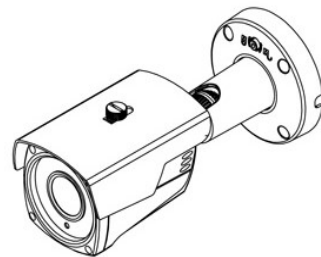
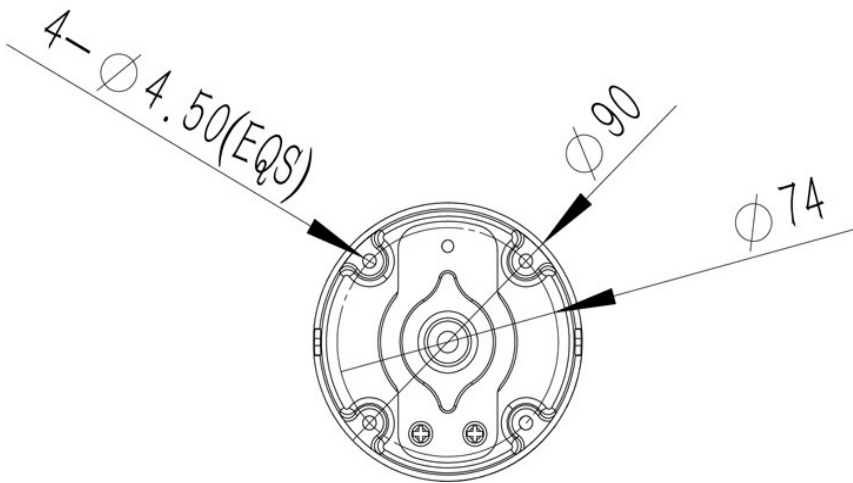
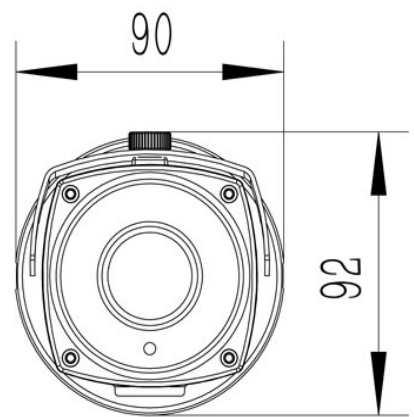
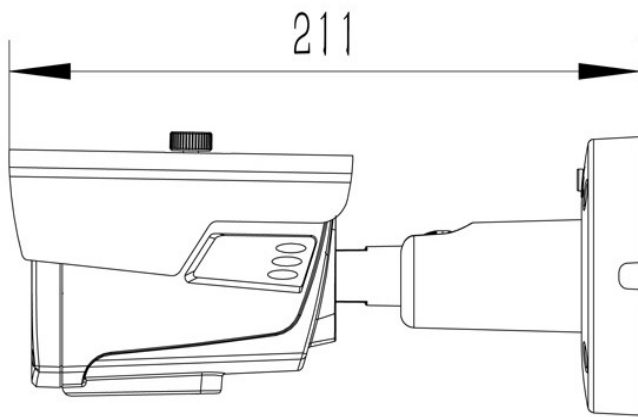

* Specifications are subject to change without notice.