

1 PET SETTINGS

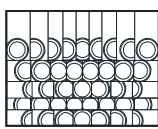

Volumetric 90°
78 Zone Edges
5 Planes

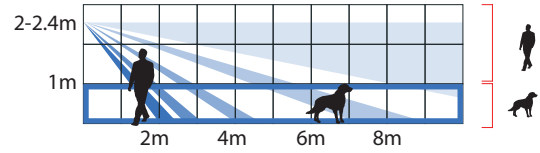
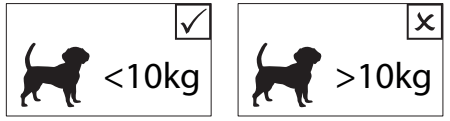
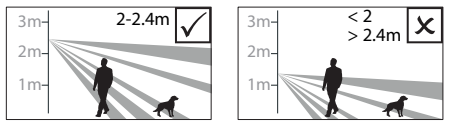
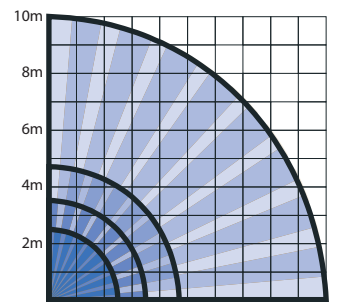

2 BRACKET CONNECTIONS

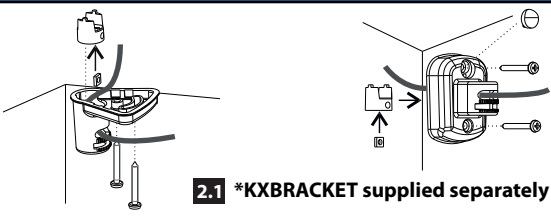

2.1 *KXBRACKET supplied separately

3 WIRING DIAGRAM

3.1 Double pole

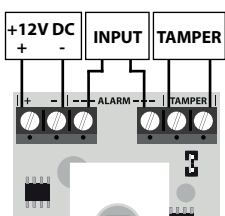

3.2 Double end of line

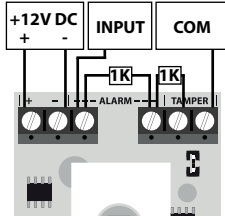

4 FALSE ALARM HAZARDS

Do not partially or completely obscure the detectors field of vision with large objects.

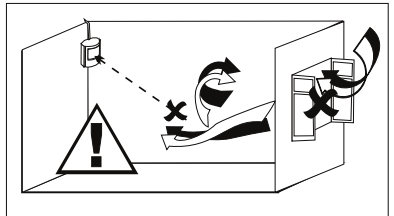
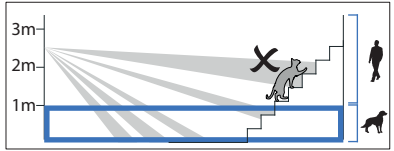
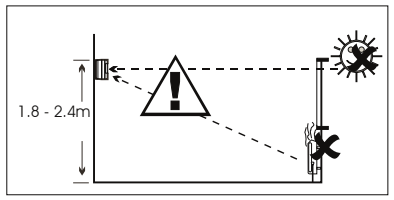
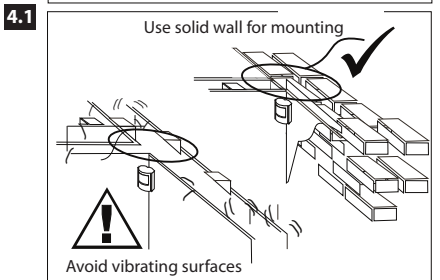
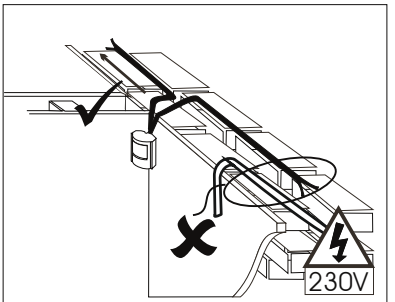

5 SENSITIVITY SETTINGS

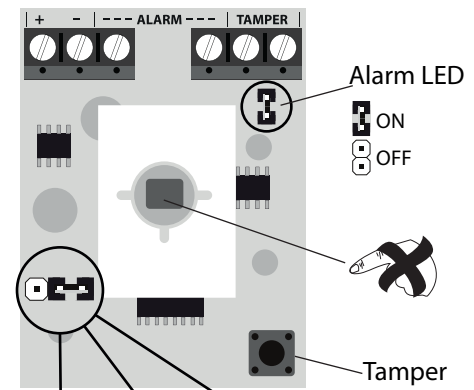

5.1 PC1
Pulse Count 1



5.2 PC2
Pulse Count 2
(default)

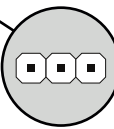

5.3 Pet
sensitivity

6 MOUNTING

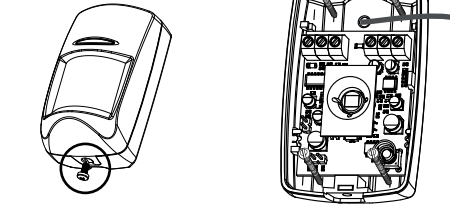
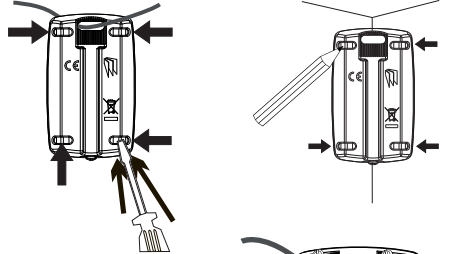

7 WARRANTY

This product is sold subject to our standard warranty conditions and is warranted against defects in workmanship for a period of five years.

In the interest of continuing improvement of quality, customer care and design, Pyronix Ltd. reserves the right to amend specifications without giving prior notice.

COLT10DL

10m Digi-logic Pet Immune Detector



Self-certified to:
EN 50131-2-2:2008
EN 50131-1-2:2006+A1:2009
PD 6662:2010
Security Grade 2
Environmental Class II

Pyronix Limited
Secure House, Braithwell Way, Hellaby,
Rotherham, South Yorkshire, S66 8QY
Customer support:
+44(0)845 6434 999 (local rate)
or +44(0)1709 535225
Hours: Mon to Fri, 8.00am till 6:30pm
Email: customer.support@pyronix.com
Website: www.pyronix.com



For electrical products sold within the European Community. At the end of the electrical products life, it should not be disposed of with household waste. Please recycle where facilities exist. Check with your Local Authority or retailer for recycling advice in your country.

This product is approved for use in the residential, commercial and light industrial environment

8 SPECIFICATIONS (QUICK REFERENCE)

Model:	Pyronix COLT10DL
Colour:	White
Weight:	58g without bracket
Dimensions:	Height = 82mm, Width = 50mm, Depth = 41mm
Casing:	3mm ABS, 0.4mm HDPE in lens area.
Detection method:	Low noise Dual Element Pyroelectric sensor
Sensitivity:	PC1, PC2 & pet
Temperature compensation:	Auto
Detection range:	10m Digi-logic
Detection zones:	78
Detection speed	0.3 - 3.0 m/s
Operating voltage:	9 - 16 VDC
Quiescent current:	15mA at 12V
Relay output:	SELV limits, 60Vdc, 50mA (42.4Vac peak)
Mounting height:	2m - 2.4m standard, 2.4m PI
Tamper switch:	12V 50mA
Storage temperature:	-40°C to 80°C
Operating temperature:	-30°C to 70°C
Emissions:	EN55022 Class B
Immunity:	Designed to new European standard EN50130-4

<p>Detector inmune a mascotas de hasta 10kg.</p> <p>1. Configuraciones para anti mascotas</p> <p>2. Conexiones de soporte. Soporte vendido por separado.</p> <p>3. Diagrama de conexiones. Conexión doble polo. Conexión doble resistencia de fin de línea</p> <p>4. Riesgo de falsas alarmas. Use una pared sólida para montar. Evite superficies vibratorias</p> <p>5. Configuraciones de sensibilidad. LED de alarma Enc/Apg. Resorte de tamper 5.1 PC1 5.2 PC2 5.3 Sensibilidad mascotas</p> <p>6. Montaje</p> <p>7. Garantía. Este producto es vendido sujeto a nuestros estándares de garantía y es garantido contra defectos de fabricación por cinco años En nuestro interés por continuar mejorando continuamente la calidad, el cuidado al cliente y los diseños, Pyronix Ltd. se reserva el derecho de modificar las especificaciones sin previo aviso.</p> <p>Este producto es aprobado para ser usado en ambientes residenciales, comerciales e industriales ligeros.</p> <p>8. Especificaciones (referencia rápida) Modelo: Pyronix COLT10DL Color: Blanco Peso: 58g sin el soporte Dimensiones: Alto = 82mm, ancho = 50 mm y profundidad = 41mm Gabinete: ABS 3mm, 0.4mm HDPE en área de lente Método de detección: Elemento piro sensor dual de bajo ruido Sensibilidad: PC1 , PC2 y mascotas Compensación de temperatura: Alto Rango de detección: 10m Digi-logic Zonas de detección: 78 Velocidad de detección: 0.3 - 3.0 m/s Tensión de operación: 9 - 16 VDC Corriente de reposo: 15mA a 12V Salida de relé: Límites SELV, 60Vdc, 50mA (42.4Vac de pico) Altura de montaje: 2m - 2.4m standard, 2.4m mascotas Contacto de tamper: 12V 50mA Temperatura de almacenamiento: -40°C Temperatura de operación: -30°C Emisiones: EN55022 Clase B Inmunidad: Diseñado para el nuevo estándar europeo EN50130-4ean standard EN50130-4</p>	<p>1. Impostazioni per Animali</p> <p>2. Connessione staffe. Staffe fornite separatamente</p> <p>3. Schema di collegamento. 3.1 Collegamento a doppia polarità 3.2 Collegamento doppio di fine linea</p> <p>4. Pericolo di falsi allarmi. Utilizzare un muro solidoper l'installazione.Evitare superfici vibranti</p> <p>5. Impostazione della sensibilità. Led di allarme ON/OFF. Molla tamper. 5.1 PC1. 5.2 PC2 5.3 Sensibilità agli animali</p> <p>6. Montaggio</p> <p>7. Garanzia. Questo prodotto e' soggetto alle nostre condizioni di garanzia standard valide in caso di difetti di realizzazione per un periodo di 5 anni. Nell'ottica di un continuo miglioramento nella qualita', cura del cliente e progettazione, Pyronix Ltd si riserva il diritto di emendare le specifiche senza preavviso. Rivelatore ad immunita' animale fino a 10m Digi-logic</p> <p>Questo prodotto e' approvato per uso in contesti residenziali, commerciali e industriali</p> <p>8. Specifiche (breve referenza) Modello: Pyronix COLT10DL Colore: Bianco Peso: 58g senza staffa Dimensioni: Altezza=82mm, larghezza=50mm, profondita'=41mm Casing: 3mm ABS, 0.4mm HDPE nella zona della lente Metodo di rivelazione: Sensore piroelettrica due elementi e basso rumore Sensibilita': PC1, PC2 & animali Meccanismo dicompensazione della temperatura: Alta Distanza di rilevamento: 10m Digi-logic Zone di Rilevamento: 78 Velocita' di rilevamento: 0.3 - 3.0 m/s Tensione operativa: 9 - 16 VDC Corrente quiescente 15mA at 12V Uscita a relé: SELV limits, 60Vdc, 50mA (42.4Vac peak) Altezza di installazione: 2m - 2.4m standard, 2.4m PI Tamper switch: 12V 50mA Temperatura di immagazzinamento -40°C Temperatura operativa: -30°C Emissioni: EN55022 Class B Immunita': Progettato in maniera conforme al nuovo standard europeo EN50130-4 ean e EN50130-4</p>	<p>Cyfrowy detektor odporny na ruch zwierząt zas. 10m Digi-logic</p> <p>1. Ustawienia dot. zwierząt</p> <p>2. Podłączenia wspornika. Wspornik dostarczany osobno</p> <p>3. Schemat połączeń. Podłączenie dwustanowe typu Double Pole. Podłączenie parametryczne typu Podwójny End of Line</p> <p>4. Ryzyka fałszywych alarmów. Mocować na pełnej ścianie Unikać wibrujących powierzchni</p> <p>5. Ustawienia czułości. Dioda LED ON/OFF gdy alarm. Sprężyna łącznika sabotażowego (tamper). 5.1 Czulość automatyczna. 5.2 Czulość wysoka 5.3 Czulość dot. zwierząt</p> <p>6. Mocowanie</p> <p>7. Gwarancja: Ten produkt objęty jest naszymi standardowymi warunkami gwarancji obejmującymi wady produkcyjne przez okres 5 lat. W interesie ciągłego polepszania jakości, obsługi klienta i projektowania, Pyronix Ltd. rezerwuje sobie prawo do zmiany dan technicznych bez wcześniejszych komunikatów.</p> <p>Ten produkt przeznaczony jest do używania w środowisku mieszkaniowym, komercyjnym i przemysłowym</p> <p>8. Dane techniczne (wersja skrócona) Model: Pyronix COLT10DL Kolor: biały Masa: 58g bez wspornika Wymiary: Wysokość = 82mm, Szerokość = 50mm, Głębokość = 41mm Obudowa: 3mm ABS, 0.4mm HDPE w obszarze soczewki. Sposób detekcji: PC1, PC2. Cyfrowa wysoka Kompensacja temperaturowa: Automatyczna Zasięg detekcji: 10m Digi-logic Ilość stref detekcji: 78 Prędkość detekcji: 0.3 - 3.0 m/s Napięcie znamionowe: 9 - 16 VDC Prąd spoczynkowy: 15mA przy 12V Parametry wyjścia: izolowane typu SELV, 60Vdc, 50mA (42.4Vac peak) Wysokość montażu: 2m - 2.4m standardowo, 2.4m PI Łącznik sabotażowy (tamper): 12V 50mA Temperatura przechowywania: -40°C Min. temperatura pracy: -30°C Emissioni: EN55022 Class B Odporność: Zaprojektowane w zgodności z nową europejską normą EN50130-4</p>	<p>10 метровый детектор с иммунитетом от домашних животных</p> <p>1. Настройка от животных</p> <p>2. Установка кронштейна. Поставляется отдельно</p> <p>3. Диаграмма подключения. Без резистора. Два резистора</p> <p>4. Причины ложных тревог. Используйте капитальные стены Избегайте дрожащих поверхностей</p> <p>5. Настройка чувствительности. Светодиод ВКЛ/ВЫКЛ Выключатель тампера 5.1 Авто чувствительность 5.2 Высокая чувствительность. Иммунитет от животных</p> <p>6. Монтаж</p> <p>7. Гарантия: Продукт подлежит стандартной заводской гарантии сроком на пять лет В целях совершенствования продукции Pyronix Ltd оставляет за собой право вносить не ухудшающие изменения без предварительного уведомления</p> <p>Продукт одобрен для использования в жилом, коммерческом и промышленном секторе</p> <p>8. Спецификация Модель: Pyronix COLT10DL Цвет: Белый Вес: 58 грамм без кронштейна Размеры: Высота=82мм, Ширина=50мм, Толщина=41мм Корпус: 3мм ABS пластик, 0.4мм линза Метод обнаружения: Низко шумный, двойной пирозлектрический элемент Чувствительность: Цифровая высокая, авто и от животных Температурная компенсация: Цифровая Дальность обнаружения: 10 метров Количество зон: 78 Скорость обнаружения: 0.3-3.0 м/с Рабочее напряжение: 9-16В пост. Тока Рабочий ток: 15mA при 12В Выход реле: 60В, 50mA пост.тока, 42.2В макс. Перем. Тока Высота монтажа: 2-2,4 метра стандарт, 2,4метра от животных Контакт тампера: 12В, 50mA Температура хранения: -40°C Рабочая температура: -30°C Соответствие: Класс В EN55022 Иммунитет: Проектировано по новому Европейскому стандарту EN50130-4ean</p>